

# Instruction Manual



## ***EMS-4 Programmable Engine Management System Wire Harness EMS P/N 30-2905-0 & 30-2905-96***



### **STOP!**

**THIS PRODUCT HAS LEGAL RESTRICTIONS.**  
**READ THIS BEFORE INSTALLING/USING!**

**WARNING!** THIS IS A RACE ONLY PRODUCT MANUFACTURED AND SOLD FOR INSTALLATION ON VEHICLES DESIGNED TO BE USED SOLELY FOR COMPETITION PURPOSES. ONCE THIS PART IS INSTALLED, THE VEHICLE MAY NEVER BE USED, OR REGISTERED OR LICENSED FOR USE, ON A PUBLIC ROAD OR HIGHWAY. IF YOU INSTALL THIS PART ON YOUR VEHICLE AND USE THE VEHICLE ON A PUBLIC ROAD OR HIGHWAY, YOU WILL VIOLATE THE CLEAN AIR ACT AND MAY BE SUBJECT TO PERSONAL CIVIL OR CRIMINAL LIABILITY, INCLUDING FINES OF UP TO \$4,819 PER DAY.

IT IS THE RESPONSIBILITY OF THE INSTALLER AND/OR USER OF THIS PRODUCT TO ENSURE THAT IT IS USED IN COMPLIANCE WITH ALL APPLICABLE LAWS AND REGULATIONS. IF THIS PRODUCT WAS PURCHASED IN ERROR, DO NOT INSTALL AND/OR USE IT. THE PURCHASER MUST ARRANGE TO RETURN THE PRODUCT FOR A FULL REFUND.

THIS POLICY ONLY APPLIES TO INSTALLERS AND/OR USERS WHO ARE LOCATED IN THE UNITED STATES; HOWEVER CUSTOMERS WHO RESIDE IN OTHER COUNTRIES SHOULD ACT IN ACCORDANCE WITH THEIR LOCAL LAWS AND REGULATIONS.

### **WARNING!**

**Improper installation and/or adjustment of this product can result in major engine/vehicle damage. For technical assistance visit our dealer locator to find a professional installer/tuner near you.**

**Note: AEM holds no responsibility for any engine damage or personal injury that results from the misuse of this product, including but not limited to injury or death caused by the mishandling of methanol.**

#### **AEM Performance Electronics**

AEM Performance Electronics, 2205 126th Street Unit A, Hawthorne, CA 90250

Phone: (310) 484-2322 Fax: (310) 484-0152

<http://www.aemelectronics.com>

## General Information

**READ AND UNDERSTAND THESE INSTRUCTIONS BEFORE ATTEMPTING TO INSTALL THIS PRODUCT. VISIT THE AEM PERFORMANCE ELECTRONICS TECH SUPPORT FORUM AT <http://forum.aempower.com/forum/index.php> ALL CURRENT SOFTWARE AND DOCUMENTATION IS AVAILABLE ON THIS FORUM.**

**YOU MAY ALSO CONTACT AEM PERFORMANCE ELECTRONICS TECH SUPPORT AT 1-800-423-0046 IF YOU HAVE ANY QUESTIONS.**

## Electronics Warranty

Advanced Engine Management Inc. warrants to the consumer that all AEM Electronics products will be free from defects in material and workmanship for a period of twelve months from date of the original purchase. Products that fail within this 12-month warranty period will be repaired or replaced when determined by AEM that the product failed due to defects in material or workmanship. This warranty is limited to the repair or replacement of the AEM part. In no event shall this warranty exceed the original purchase price of the AEM part nor shall AEM be responsible for special, incidental or consequential damages or cost incurred due to the failure of this product. Warranty claims to AEM must be transportation prepaid and accompanied with dated proof of purchase. This warranty applies only to the original purchaser of product and is non-transferable. All implied warranties shall be limited in duration to the said 12-month warranty period. Improper use or installation, accident, abuse, unauthorized repairs or alterations voids this warranty. AEM disclaims any liability for consequential damages due to breach of any written or implied warranty on all products manufactured by AEM. Warranty returns will only be accepted by AEM when accompanied by a valid Return Merchandise Authorization (RMA) number. Product must be received by AEM within 30 days of the date the RMA is issued.

Please note that before AEM can issue an RMA for any electronic product, it is first necessary for the installer or end user to contact the tech line at 1-800-423-0046 to discuss the problem. Most issues can be resolved over the phone. Under no circumstances should a system be returned or a RMA requested before the above process transpires.

AEM will not be responsible for electronic products that are installed incorrectly, installed in a non approved application, misused, or tampered with.

Any AEM electronics product can be returned for repair if it is out of the warranty period. There is a minimum charge of \$50.00 for inspection and diagnosis of AEM electronic parts. Parts used in the repair of AEM electronic components will be extra. AEM will provide an estimate of repairs and receive written or electronic authorization before repairs are made to the product.

## EMS-4 Basic Specifications

### EMS-4 Specifications

CPU Core:	16 bit / 40 MHz
Injector Drivers:	4 x Saturated (8 ohm minimum, <b>High Impedance Only</b> )
Coil Drivers:	4 x 0-5V Falling Edge Fire ( <b>do not connect directly to coil primary</b> )
GPIO Pins:	4 x 1.5A Low Side Output / 0-5V Analog Input / Switch Input 4 x 1.5A Low Side Output / 0-5V Analog Input / PWM output
O2 Sensor Input:	1 x 0-5V analog
Timing Sensor Inputs:	1 x VR (mag) Cam Input 1 x VR (mag) Crank Input 1 x Hall VSS Input 1 x Hall Crank Input 1 x Hall Cam Input
Knock Sensor Input	1x Programmable
Throttle Position Input	1 x 0-5V
Manifold Pressure Sensor	1 x 0-5V
Coolant Temperature Sensor	1 x analog
Inlet Air Temperature Sensor	1 x analog
USB	1 x EMS / PC Communication
CAN	1 x Programmable Send / Receive
Sensor Ground	1 x
5 Volt Reference	1 x

## Wire Harness Options



EMS-4 with 30-2905-96 Full Harness



EMS-4 with 30-2905-0 Mini Harness

# AEM 30-2905-0 HARNESS

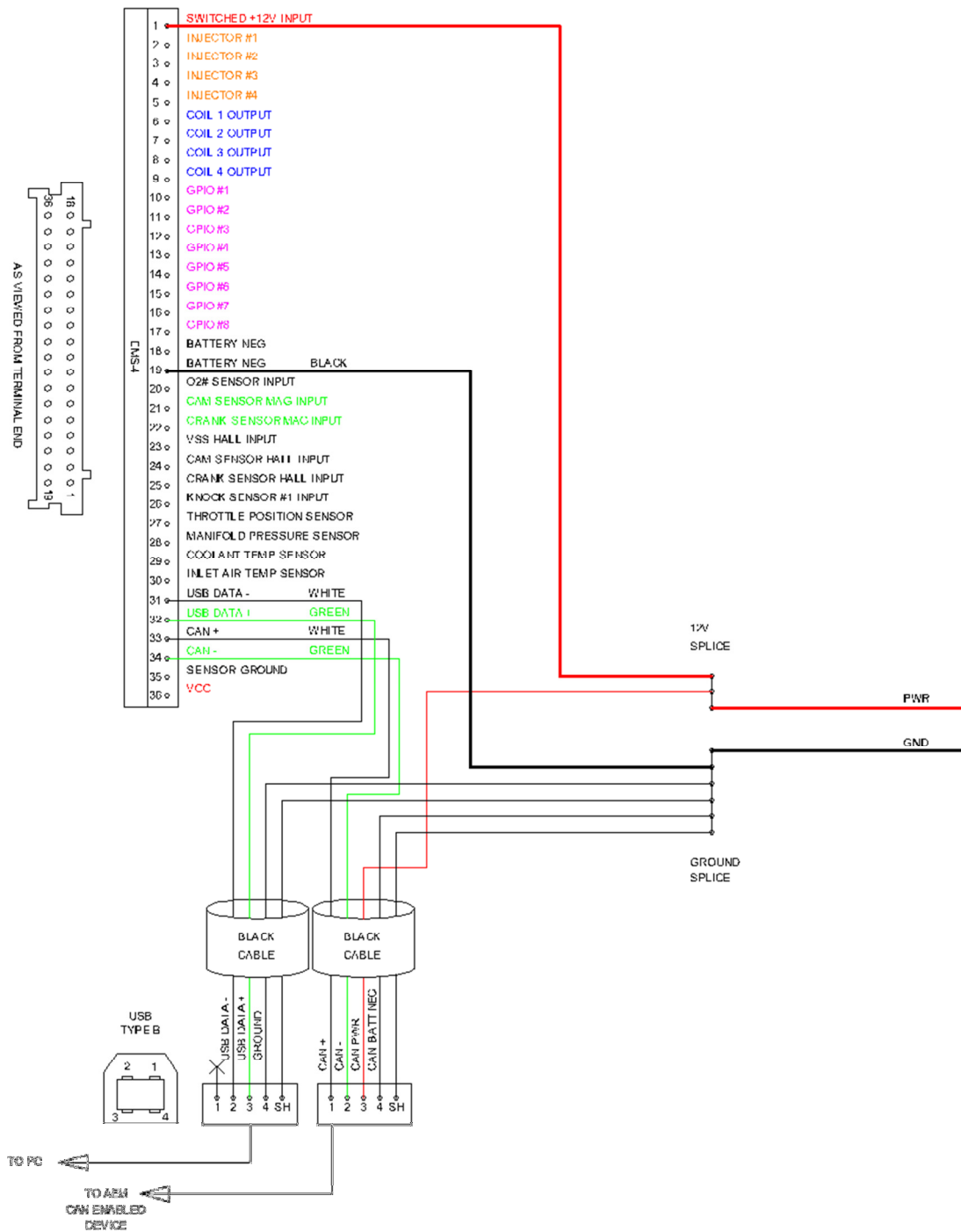

<p>UNLESS OTHERWISE SPECIFIED DIMENSIONS ARE IN INCHES TOLERANCES ARE:</p> <p>FRACTIONS    DECIMALS    ANGLES</p> <p>± 1/16"    .XX    ± 0.01    ± 1°</p> <p>            .XXXX    ± 0.005</p>	<p>CAD GENERATED DRAWING, DO NOT MANUALLY UPDATE</p>																			
<p>MATERIAL</p>	<table border="1" style="width: 100%; border-collapse: collapse;"> <tr> <th style="width: 50%;">APPROVALS</th> <th style="width: 50%;">DATE</th> </tr> <tr> <td>DRAWN    SCA</td> <td>12/1/10</td> </tr> <tr> <td>CHECKED</td> <td>---</td> </tr> <tr> <td>RESP ENG</td> <td>---</td> </tr> <tr> <td>MFG ENG</td> <td>---</td> </tr> <tr> <td>QUL ENG</td> <td>---</td> </tr> </table>	APPROVALS	DATE	DRAWN    SCA	12/1/10	CHECKED	---	RESP ENG	---	MFG ENG	---	QUL ENG	---	<p><b>30-3905-0</b> <b>EMS-4 MINI HARNESS</b></p>		<table border="1" style="width: 100%; border-collapse: collapse;"> <tr> <td style="width: 50%;">SIZE DWG. NO.</td> <td style="width: 50%;">REV.</td> </tr> <tr> <td style="text-align: center;">A</td> <td style="text-align: center;">A</td> </tr> </table>	SIZE DWG. NO.	REV.	A	A
APPROVALS	DATE																			
DRAWN    SCA	12/1/10																			
CHECKED	---																			
RESP ENG	---																			
MFG ENG	---																			
QUL ENG	---																			
SIZE DWG. NO.	REV.																			
A	A																			
<p><b>DO NOT SCALE DRAWING</b></p>	<p>SCALE: NONE    CAD FILE:</p>		<p>SHEET 1 OF 1</p>																	



Two partially assembled harness options are available for the EMS-4:

1. P/N 30-2905-96 EMS-4 Full Harness
2. P/N 30-2905-0 EMS-4 Mini Harness

Photographs and schematics for each are shown above. The Full Harness option is best suited to applications where no factory harness exists or where modifications are so extensive, it is easier to build a custom harness. This harness includes a fused power distribution center with main relay. All circuits are pre-terminated at the ECU connector. All sensor input and actuator output leads are grouped and clearly labeled. All power and ground splices are pre-configured. All sensitive communications and CAN data stream circuits are pre-configured.

The Mini Harness option is best suited to applications where the factory harness is suitable as a starting point for modifications. Like the fully populated harness, the mini version includes pre-terminated CAN data stream and communications circuits. It also includes primary power and ground inputs. This is the minimum required for powering up the EMS and enabling communications. All other harness terminations are the responsibility of the installer. A bag of Delphi/Packard female terminals is included for terminating all circuits at the main ECU connector.

***Installers choosing the Mini Harness option should refer to the Full Harness schematic above and the EMS-4 System Diagram that shows an example of a complete system design. The EMS-4 System Diagram is included with the software installation for AEM Kit P/N 30-6905, EMS-4 Programmable Engine Management System.***

## ECU Terminations with Mini Harness, P/N 30-2905-0

The following steps illustrate how to open the ECU connector backshell so additional circuits can be added.

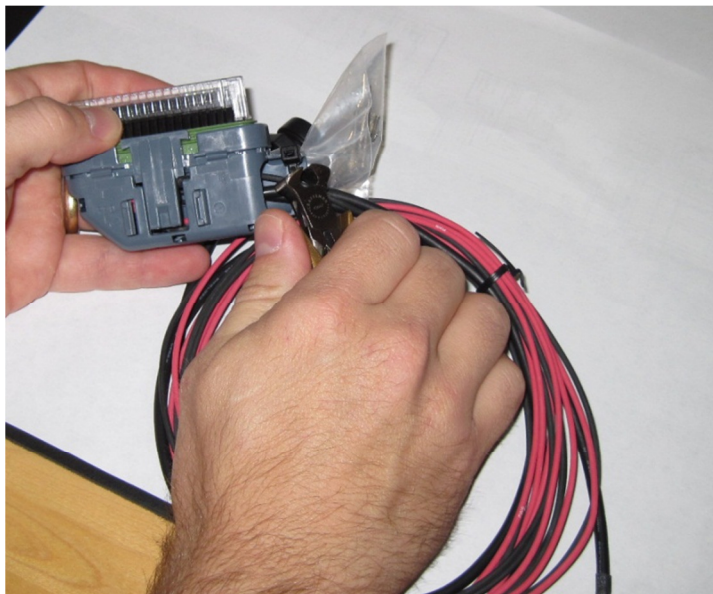

Begin by cutting the strain relief tie wrap holding the terminal bag as shown.



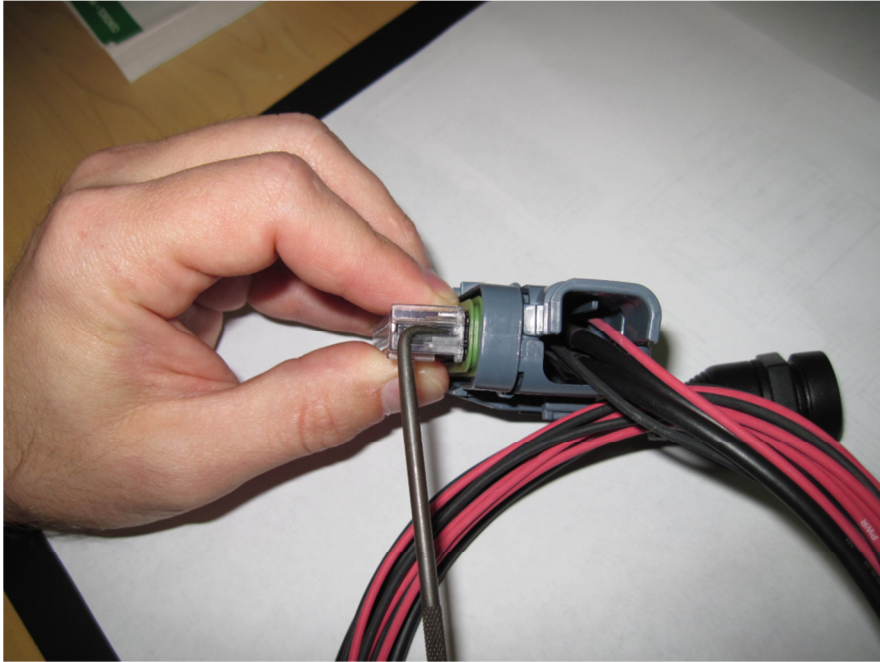

Using a sharp pick or probe, push in on the locking tabs holding the outer retainer.

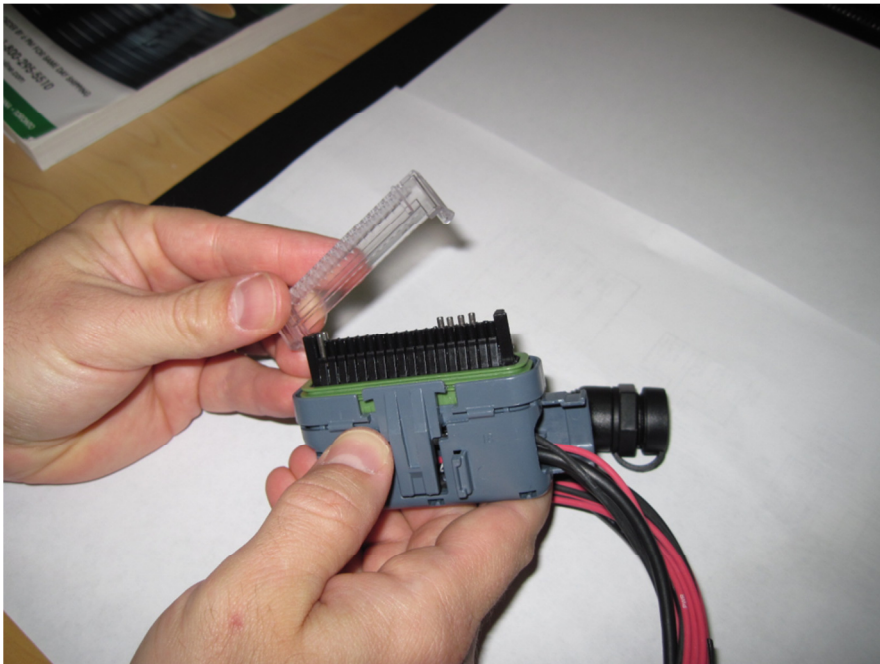

Remove the retainer.

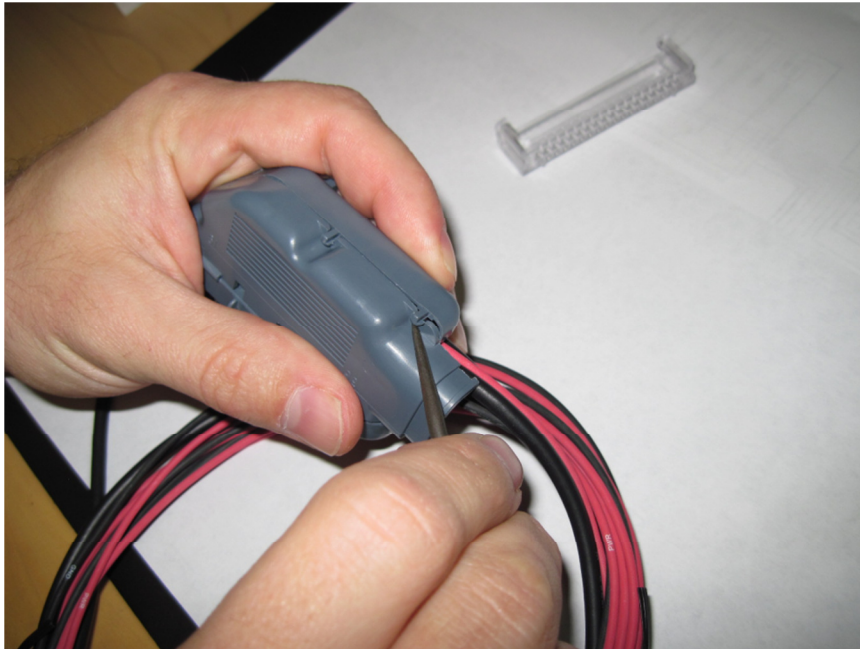

Use pick to pry open the retaining tabs holding the backshell halves together.

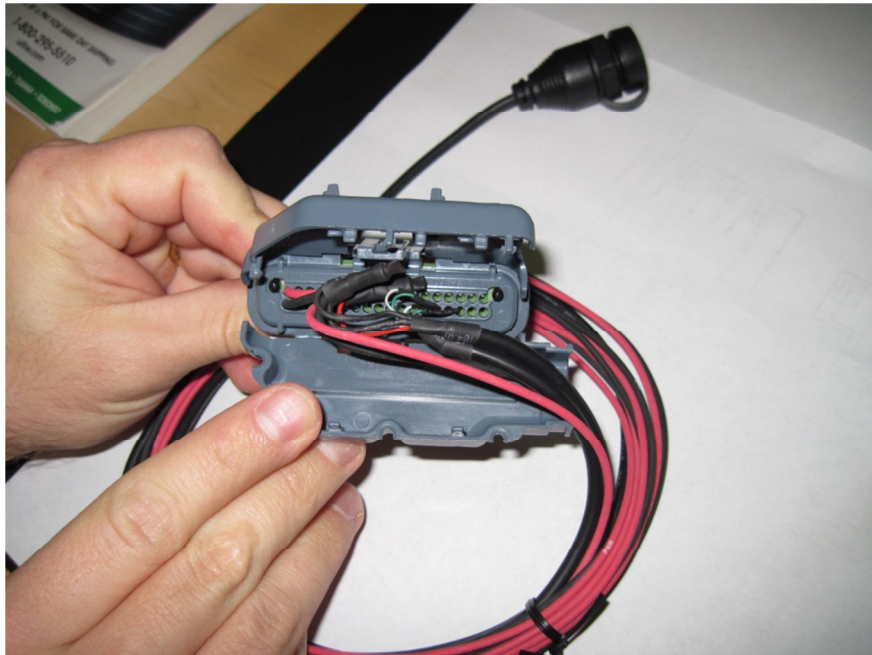

Open the shell to expose the cavities.



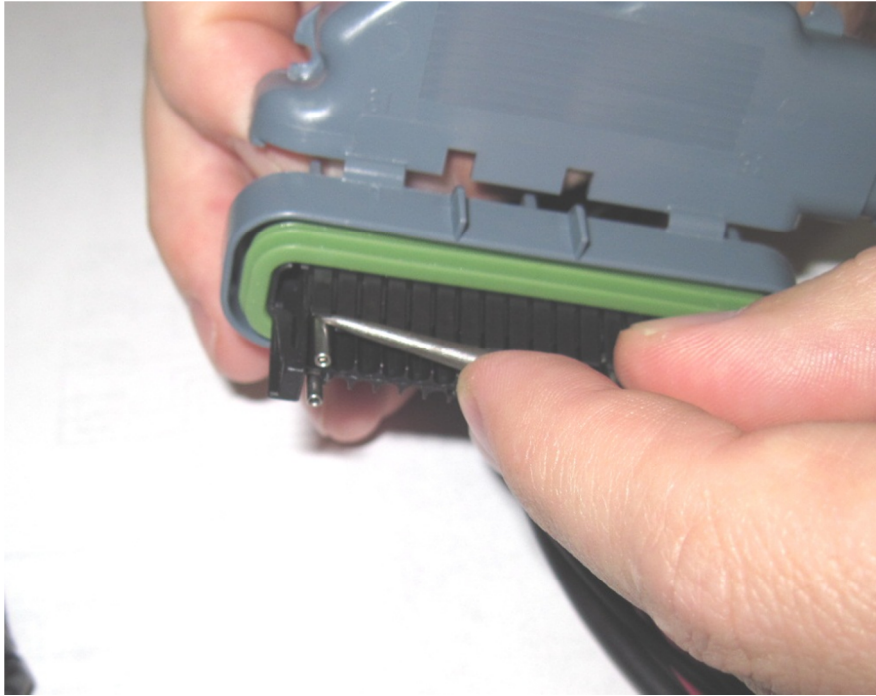

To remove a terminal, carefully pry up on the retaining clip. Be careful as the clips can break if bent too far.

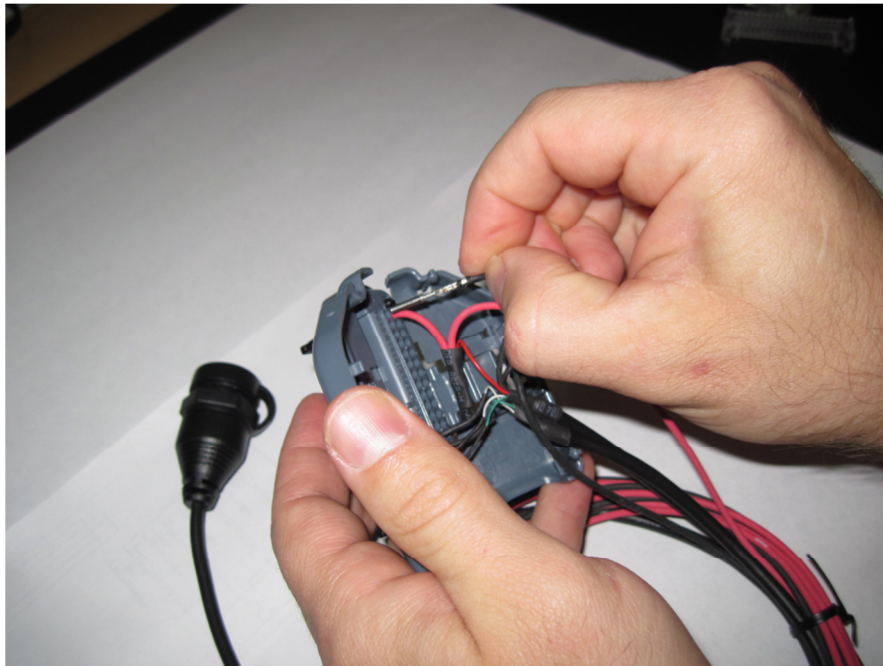

To add a new circuit, insert the terminal from the back as shown until it clicks into place.



Showing terminal fully seated.

Following is the proper tool for use with the Delphi Micro Pack terminals used in the ECU main connector.

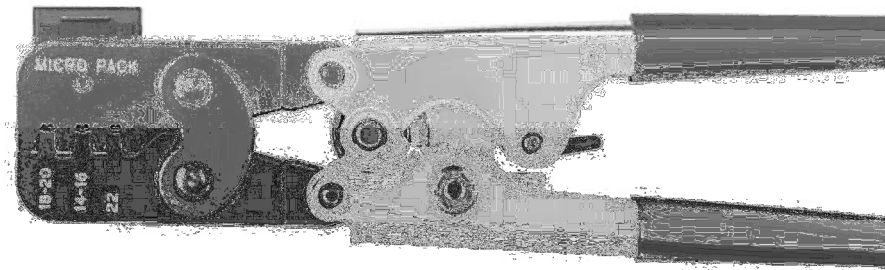

**Delphi Part No: 12070948**

Application: Unsealed Micro-Pack 100, Female only

Core and Insulation

Cable Range (mm<sup>2</sup>): 2.0-0.35

The tool is available in many places. One is shown below. Web address – <http://www.mouser.com> AEM recommends using the proper tool for all ECU terminations.

The screenshot shows the Mouser Electronics website interface. At the top, there is a navigation bar with the Mouser Electronics logo (a tti company), contact information (817) 804-3888, and links for Contact Us, Feedback, View Cart, and Change Country. Below this is a search bar with the text "Part # / Keyword (English Only)" and a "Search" button. Navigation tabs include Products, Suppliers, Catalog, Project Manager, EZ Buy, Order History, and Help. Language and currency are set to English and USD. The main content area is titled "Product Detail" and shows the breadcrumb "All Products » Interconnects » Automotive Connector Accessories » 12070948". A product image of a hand crimping tool is shown with a "Larger Image" link. Product details include: Mouser Part #: 829-12070948, Manufacturer Part #: 12070948, Manufacturer: Delphi Connection Systems, and Description: Automotive Connector Accessories HAND CRIMPER. An "Availability" section shows "Stock: 2 Can Ship Immediately", "On Order: 0", and "Factory Lead-Time: 8 Weeks". A "Pricing (USD)" section shows "1: \$145.92" and "25: \$134.69" with a "Get Quote" link. A "Specifications" table lists: Manufacturer: Delphi Connection Systems (checked), Product Category: Automotive Connector Accessories (checked), RoHS: Not Applicable, Product: Application Tooling Hand Crimper (checked), and Packaging: Bulk. There are buttons for "Add to Compare List" and "Show Similar", and a note "Show Stocked Products With Similar Attributes. Found: 3".



Image shows a properly crimped terminal. Top View.



Side View. After crimping, be sure to do a pull test to make sure the terminal is properly installed.

#### ***General note on wire terminations***

A proper wiring job includes proper termination of the wire at the sensor. The wire terminal end must be moisture tight where it plugs into the sensor and it must have strong, electrically sound terminals. The preferred method of securing a wire to a terminal is to use a crimp terminal with NO solder. It is important to use the proper crimping tool for sound terminal construction. Plastic terminal plugs must have moisture tight seals. Inspect each plug to make sure the seals are in place. Also, before the plug is installed on the sensor, apply a dab of di-electric grease in the terminal slots to further aid in corrosion resistance.

If a splice into a wire must be made and no solder-less terminals are available, then you must properly solder the splice.