



Installation instructions

📍 10023 BMW

BMW 02 / E30 / E36 / E46
5/6-Speed transmission
Getrag, ZF
Standard + Dog Leg H

WWW.CAE-RACING.DE

WWW.CAE-RACING.DE

02 / E30 / E36 / E46



PLEASE NOTE

SAFETY FIRST!

- 📍 Raise the vehicle safely with a vehicle lift for installation. Improper lifting can cause damage to the vehicle and/or personal injury or even death!
- 📍 Please only do the installation if you have appropriate experience in the automotive sector and have the right tools! An incorrectly installed Shifter can seriously damage the transmission or make the vehicle undriveable or not shiftable and lead to serious accidents!
- 📍 If work on the electrical system is necessary, please follow the manufacturer's specifications.
- 📍 Carry out all work with care and cleanliness! For the professional assembly of a shifter is no force required. All parts are designed to fit your vehicle.
- 📍 If you are unsure, please contact your trusted workshop about the installation!

BASICALLY

- 📍 Use ethyl alcohol/brake cleaner to clean all aluminum parts.
- 📍 Occasionally lubricate all moving parts with spray grease, which has good creeping properties. Our recommendation: Würth HHS 2000 (WD-40 or similar is unsuitable because it is too thin)
- 📍 All screws and nuts that are not self-locking or are fitted with tooth lock washers glue in during assembly!

📍 SURFACES AND THEIR CARE

Please note that an untreated aluminum surface (ALU) is sensitive to aggressive Liquids to which i.a. Hand sweat also counts. Especially the high-strength 7075 aluminum we use has a tendency to form black spots of corrosion due to its high copper content. Under special circumstances, very salty air near the sea and coast can lead to corrosion. The surfaces should therefore be cleaned regularly and treated with care to prevent this. For this purpose, e.g. ethyl alcohol or brake cleaner. Only spray these onto a cloth and wipe the shifter with it, NEVER spray the shifter directly. If stains have already formed, they can be removed with commercially available aluminum polish, but that is also not allowed get into the movable parts of the shifter. The anodized versions of our shifters (EXS, EXGR) are more resistant to corrosion. The steel parts have to be also cared in all variants.

TIPS FOR GEAR SHIFTING

📍 FORCE DOESN'T MAKES YOU FASTER - IT ONLY HARMS THE TRANSMISSION

The question arises again and again: "Does a CAE shifter puts more strain on a gearbox than a standard gear lever?" The answer is clear: "No!" The things that are most stressful for a synchronizer ring in a transmission are excessive shifting forces or a wrong shift in gear. Basically, the shift travel with a CAE Shifter is significantly shorter than with the standard lever. We achieve 30 - 55 % reduction depending on the vehicle and transmission type. This can only be achieved by using the appropriate gear ratio on the shift lever. You can feel it through the precision of a CAE shifter engaging the gears is much better than with a standard gear lever designed for comfort. The force for this decreases in the same proportion - we put in the gears with significantly less load for the synchronizer rings. In addition, with a correctly adjusted CAE shifter put in the gears is very precise and shifting into the wrong gear is extremely rare. Even in motorsport, fast, precise, but still sensitive shifting leads to the goal! Everything else is pure tugging and tearing (often seen on various YT channels), which looks "important", but in no way makes it faster - but it puts a disproportionately high strain on a transmission and in the worst case causes a fatal wrong shift in gear!

THE ROTATABLE GEAR LEVER LOWER PART

ⓘ THAT SHOULD NEVER BE DISMANTLED! The following pictures illustrate the principle of the rotatable gear lever lower part and they are for illustration purposes only!

- 📍 The fixing screw engages in the groove of the lower part of the gearshift lever and fixes it axially - and it may never be tightened! The lower part of the shift lever must remain rotatable.
- 📍 **Familiarize yourself with this principle before installing the shifter!** Memorize the insertion depth of the lower part, where the fixing screw engages in the groove. The lower part of the gearshift lever must be able to turn without resistance in the gearshift lever! This is a condition for proper function.
- 📍 The basic setting for the fixing screw: screw in **carefully** until the pin tip touches the bottom of the groove. Then turn back $\frac{1}{4}$ turn. Now hold the grub screw with a 2.5 mm allen key and tighten the nut (this is the default). Make sure that the grub screw is secured with the supplied wire after assembly!
- 📍 **Regularly spray penetrating oil into the \varnothing 2.5 mm lubrication hole above the fixing screw!**
This is absolutely necessary for perfect function! Pay attention to cleanliness!
- 📍 We recommend Würth HHS 2000 for lubrication.

📍 DIRT, GRINDING DUST OR A LACK OF LUBRICATION IN THIS BEARING LEAD TO FAILURE OF THE SHIFTER WITHIN A VERY SHORT TIME!



THE SPRING STOP

ⓘ NEVER UNSCREW THIS SCREW COMPLETELY!

By loosening (max. 2 turns) the screw on the Spring stop, the zero position of the gearbox can be determined. Please **never** completely loosen this screw as you will never get the mechanism together under the car again, only with the total loss of nerve costume!

A 5 mm Allen key is required for this screw.



i The shifter is intended for racing vehicles without interior equipment. If the center console is installed, it must be removed or cut out until there is sufficient clearance for the shifter. The shifter must be screwed onto the sheet metal of the center tunnel and any existing carpet must be cut out.

For a smooth installation 2 persons are advantageous.

Disassembling

- ▶ Lift the vehicle safely on a vehicle lift. Shift transmission to neutral. Remove center console panels, at least remove shift boot, frame and ashtray to gain access to tunnel plate.



Working under the car

- ▶ Remove the underbody panelling. To remove the shift rod, loosen the exhaust and the transmission bridge if necessary, support the engine appropriately and slowly tilt it back. This makes it much easier to reach the shift rod. Make sure that the shims of the shift rod are not lost.
- ▶ Completely remove the original gearshift including the shift lever bearing. First, remove the rear bolt of the shift rod from the shift lever by pulling the safety clip off the bolt (Picture 1).
- ▶ To pull the shift lever out of the bearing, use a screwdriver to press the tabs of the plastic ball mount into the openings on the side (Picture 1). Remove the shift lever upward.
- ▶ The aluminum shift lever bearing (Picture 2) is secured on the gearbox side with two bolt clamps (Picture 3, picture 4 on page 2), which are clipped onto the gearbox housing. Press the clips up with a long screwdriver and pull the bolts out sideways.
- ▶ Then unscrew the rear body mount (Picture 2) and thread the shift lever bearing down out of the tunnel. To do this, twist and turn the part accordingly to get it past the propshaft (it really fits!).

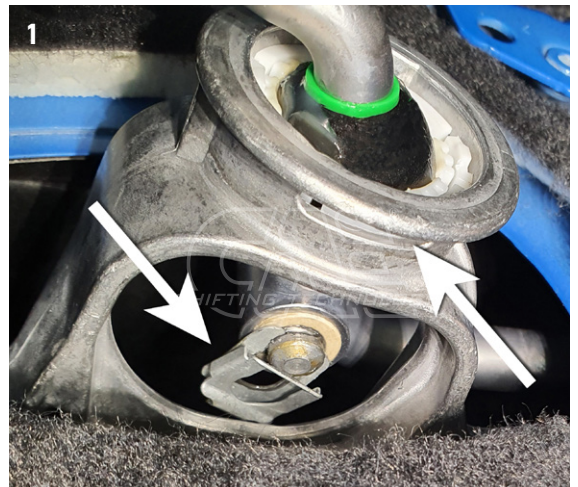



- ▶ The original shift rod (Picture 5) is also secured with a safety clip. The shift rod does not have to be removed for further use with the shifter.
- ▶ **If a CAE shift rod is to be used** (see also "Optional accessories" on page 4), the original shift rod must be removed and the following procedure followed:
 - ▶ Remove the original shift rod completely. To do this, push the safety clips off the 10 mm bolts of the shift rod and remove the shift rod laterally (Picture 5-9).
 - ▶ Then press the locking ring off the gear connection piece and then press the 6 mm bolt out of the gear connection. Due to the tightness above the gearbox in the center tunnel, patience is required here! 😊

ⓘ The foam inlay, dowel pin and locking ring from the original adapter are still used! (Picture 10).



The installation

▶ For a proper function of our shifter, the shift rod must be 100% free of play. If this is not guaranteed and the original shift rod has play or the shifter is to be changed in position, we recommend our adjustable shift rod 10023 ROD-AL ("Optional accessories" on page 4). Please inform yourself about the necessary lengths for your application.

- ▶ Loosen the spring stop (Picture 11, also 19 on page 5/6) under the switch bracket until it can be moved sideways and the spring is ineffective.
- ▶ Place the shifter with the cover plate (without bellows) on the center tunnel and provisionally insert the shift rod into the eye of the lower part of the shift lever.
- ▶ Now, with the shifter in place, first tighten the spring stop.

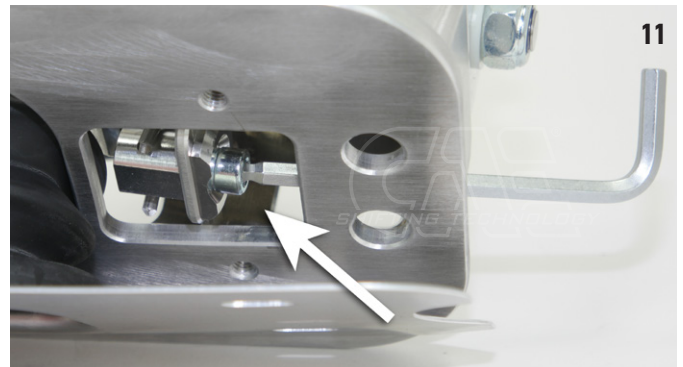

ⓘ Never unscrew the screw of the spring stop completely! (see information "The spring stop")

- ▶ Center the shift lever in the sheet metal (Picture 12+13), shift lever is slightly tilted back. If you want the shift lever to be more vertical, you can move the entire unit forward accordingly.
- ▶ Now mark and drill the \varnothing 6.5 mm mounting holes.
- ▶ Before final assembly, apply foam rubber or body sealant under the cover plate of the switching unit (Picture 14) to ensure gas tightness.
- ▶ Mount the rubber bellows on the cover plate before assembly. Please degrease the lower collar (Picture 16 on page 4) beforehand!
- ▶ Mount the upper collar (Picture 15) with a little brake cleaner. Check this immediately for correct fit! The bead of the rubber bellows must later fit into the circumferential groove on the shift lever.

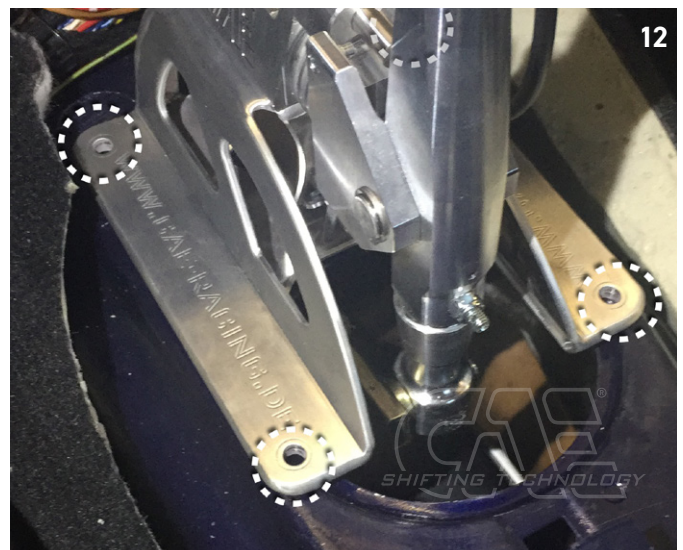



- ▶ Fit the shift unit, inserting the lower part of the shift lever (greased, Picture 17) through the bellows. Check this immediately for correct seating! The upper collar must be seated in the groove on the shift lever.
- ▶ Screw down the shifter (Picture 17). 2 persons may be required for this. Optionally, the two sheet metal latches with the pull-in nuts can be used (Picture 18). Mount the screw heads from above.

ⓘ If the original shift rod is used, please check for collision to the mounting screws!

- ▶ Fasten the shift rod. Reassemble the motor/gear unit properly. Adjust the shifting travel as follows.

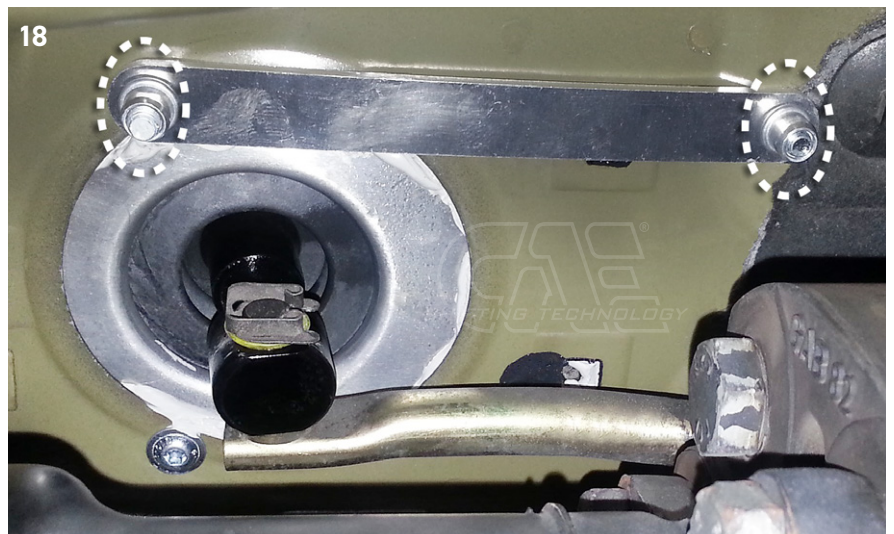
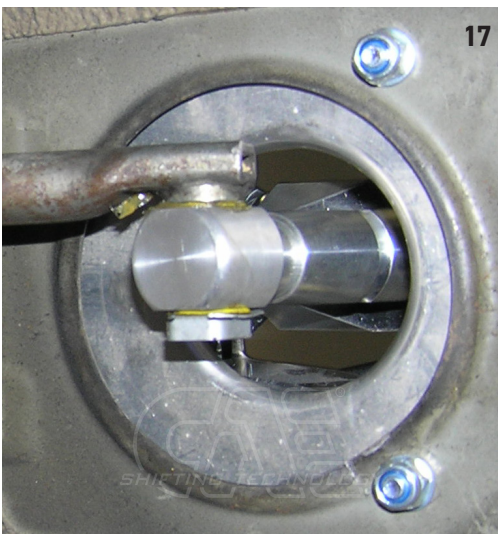

Optional accessories

ⓘ CAE Shift Rod for 10023 Series Shifter

When sitting very far back in the vehicle, the position of the shifter can be shifted accordingly.

For this we recommend our adjustable shifter rods 10023ROD-AL - available in 7 different lengths.

The same applies to extreme loads in motor sports. Also for this we recommend our Shift Rods.

Suitable for Getrag + ZF.

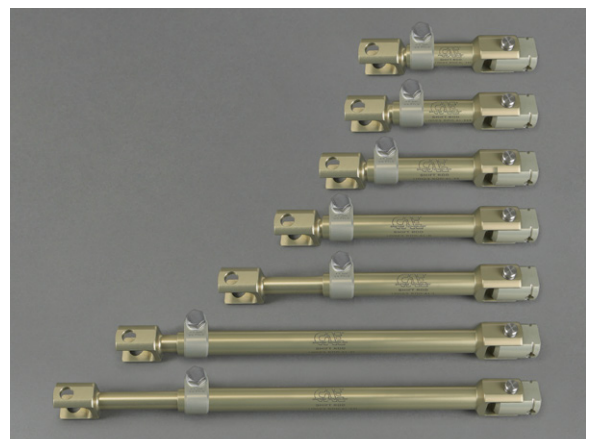

Adjustment of gear shift paths

Getrag 5-speed racing gearbox ▶ 1st gear rear left

- ▶ Loosen the stop for the center position spring under the switch bracket (Picture 19).
- ▶ Shift the gearbox to 2nd or 3rd gear. This is the "zero position" of the transmission. To do this, simply move the shift lever forwards or backwards.
- ▶ Tighten the spring stop.
- ▶ Shift the gearbox to gear level 1 using the shift lever and screw in the stop screw until 1st gear can be engaged cleanly (Picture 20).
- ▶ Now shift the transmission to the 4/5 gear level using the shift lever and screw in the stop screw until the 4th and 5th gears can be engaged cleanly.
- ▶ Actuate the locking pin via the pull and shift the gear unit to the reverse gear level. Screw in the stop screw until the reverse gear can be engaged cleanly.

PLEASE NOTE!

R and 1st gear are not on one level!

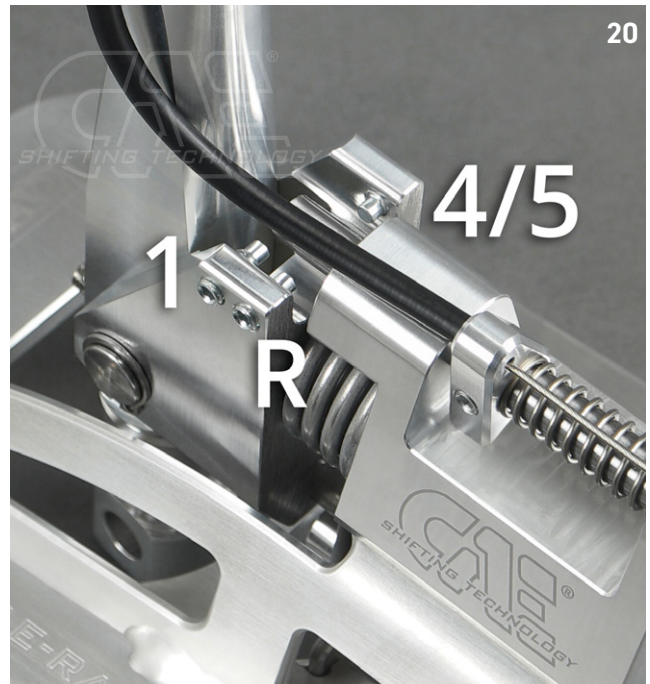

TEST: With 2nd and 3rd gear engaged, the lateral play at the shift lever must be equal. If this is not the case, the spring stop must be re-adjusted. (0.5 mm is already a lot here)

This is the basic setting of the shifter and should be done very accurately. The shift lever should be positioned laterally straight or slightly tilted to the right!

The perfectly adjusted center position is a combination of shift rod and spring stop.

PLEASE NOTE: In gears 1 and 4/5 the grub screw must not touch the locking pin when the gear is engaged!

Approx. 0.3 mm air is okay!

FINALLY check all functions and settings during the test drive and readjust if necessary!

Incorrect or inaccurate settings can cause damage to the gear box and consequential damage!

Adjustment of gear shift paths

Getrag 5/6-speed gearbox ► 1st gear front left

- ▶ Loosen the stop for the center position spring under the switch bracket (Picture 19).
- ▶ Shift the gearbox to 2nd or 3rd gear. This is the "zero position" of the transmission. To do this, simply move the shift lever forwards or backwards.
- ▶ Tighten the spring stop.
- ▶ Shift the gearbox to gear level 1/2 using the shift lever and screw in the stop screw until 1st and 2nd gear can be engaged cleanly (Picture 21).
- ▶ Now shift the transmission to the 5/6 gear level using the shift lever and screw in the stop screw until the 5th and 6th gears can be engaged cleanly.
- ▶ Actuate the locking pin via the pull and shift the gear unit to the reverse gear level. Screw in the stop screw until the reverse gear can be engaged cleanly.



TEST: With 3rd and 4th gear engaged, the lateral play at the shift lever must be equal. If this is not the case, the spring stop must be re-adjusted. (0.5 mm is already a lot here)

This is the basic setting of the shifter and should be done very accurately. The shift lever should be positioned laterally straight or slightly tilted to the right!

The perfectly adjusted center position is a combination of shift rod and spring stop.

PLEASE NOTE: In gears 1/2 and 5/6 the grub screw must not touch the locking pin when the gear is engaged!

Approx. 0.3 mm air is okay!

FINALLY check all functions and settings during the test drive and readjust if necessary!

Incorrect or inaccurate settings can cause damage to the gear box and consequential damage!

CAE wishes you a good trip.

RACE THE ORIGINAL



Alte Bottroper Strasse 103
D-45356 Essen
0049. 201. 8 777 802
service@cae-racing.de

WWW.CAE-RACING.DE