

INSTALLATION INSTRUCTIONS

FUEL PUMP HANGER

08-21 SUBARU IMPREZA/WRX/STI/FORESTER

05-09 SUBARU LEGACY/OUTBACK

Support: info@radiumauto.com

Document# 19-0295

WARNING: DO NOT EXPOSE WORK AREA TO ANY SPARKS OR FIRE. DO NOT SMOKE WHILE OPERATING ON THE FUEL SYSTEM. CLEAN UP ALL FUEL SPILLS IMMEDIATELY. WORK IN A WELL VENTILATED AREA.

1. **NOTE:** It is recommended this install be performed with a minimal amount of fuel in the tank. This will reduce fuel spills and make installation easier and safer.

To depressurize the fuel system, disconnect or remove the fuel pump fuse and start the engine. Allow the engine to stall. Remove ignition key and disconnect the battery (as shown).

Caution: Disconnecting the battery (G1) may cancel the fault memories of some control units. Consequently, before disconnecting the car's battery, always interrogate the fault memories.

Unscrew the gas tank filler cap temporarily to relieve any residual air pressure.

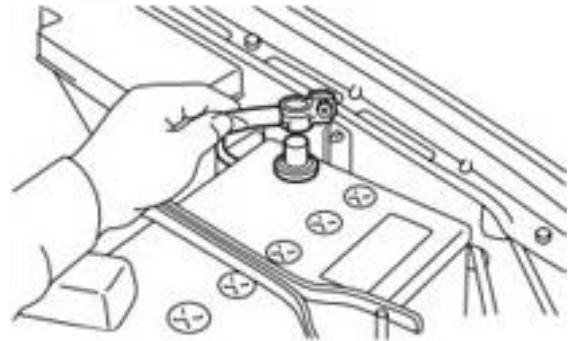

2. To remove the rear bench seat, pull the RH (shown) and LH clip latches forward to release. Next, find the center point of the seat, reach underneath and pull straight up.

Dislodge the wire loom stay. For 08-14 models only, disconnect the white connector (shown).

Next, unscrew the 4 Phillips head screws securing the metal cover plate (shown). Squeeze the tabs and unplug the electrical connector on the fuel hat. Pull the harness and grommet through the hole. Set the metal cover aside and remove the foam.

NOTE: It is recommended to clean the top of the fuel pump housing and the surrounding area as it will likely be very dirty. This will prevent loose dirt from falling into the fuel tank.

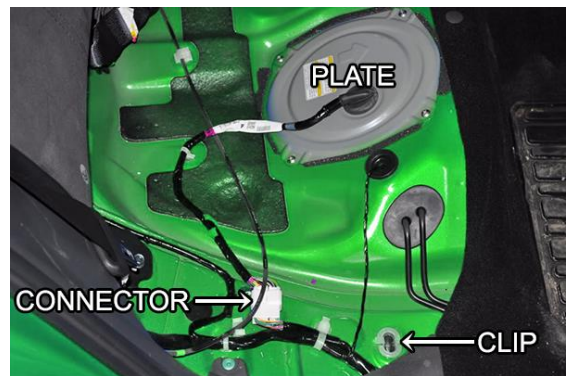

3. Prior to removing the 3 fuel connectors, note where each routes. First, push the female SAE quick connectors further onto the receiver mating tube. Squeeze the 2 plastic tabs and simultaneously slide the tubes off. Have a rag handy as fuel will instantly leak out of these connections. Use a micro screwdriver or a pick to gently remove the white plastic retainers. Reinsert them into the fuel tubing connectors.

Using an 8mm socket wrench, loosen the eight M5 nuts. Next, hold the fuel pump housing down with one hand and remove each nut one by one by hand as the housing is slightly spring-loaded. Finally, remove the black steel bracket (it will NOT be reused).

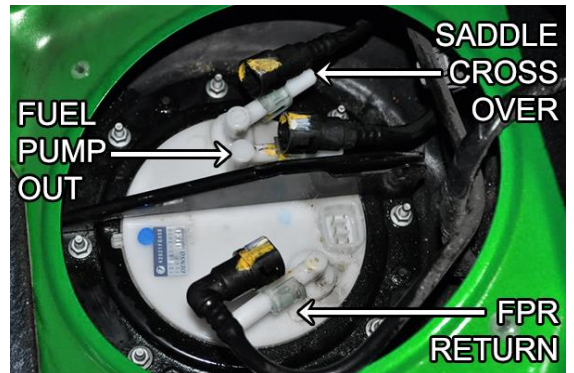

4. Before removing the OEM fuel pump, place an empty bucket nearby as there will be residual fuel inside the gas tank. Also, be careful not to damage the fuel level sender float arm when removing. A trick is to tilt the fuel pump housing towards the left side of the vehicle then pull up and out. Place the pump housing into the bucket to drain.

Remove the large rubber gasket (shown top right). Note that this gasket is not symmetrical and has a specific orientation. There are 3 protruding rubber tabs that must be aligned correctly.

Clean the fuel pump housing and set it onto a workbench. The only two parts that will be reused are the fuel level sensor and the fuel temperature sensor (if equipped).



5. NOTE: skip over all steps regarding the fuel temperature sensor for newer Subaru models that did not come standard with this sensor.

To remove the sensors, depress the thumb tab and unplug the 4-pin connector from underneath the top hat. Next, pry and pop the fuel temp sensor out of the securing tabs.

To remove the fuel level sensor, carefully press the thumb tab and simultaneously push the module up gently until it unlocks. NOTE: OEM EJ25 fuel pump module shown.

Skip steps 6-14 if the Radium unit came preassembled with fuel pumps already installed and the vehicle does not have a temperature sensor.

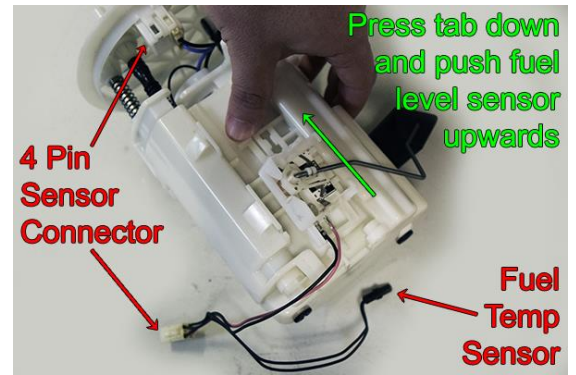

6. The unit must be disassembled to install pumps and/or the OEM fuel temp sensor.

Using a 3mm Allen wrench, remove the 3 external bolts on the sides of the collector box. NOTE: the 2 lower collector box bolts on the one side are only used for 2015+ FA20 Subaru fuel level sensors. For all other models, these bolts are used as “plugs” and can remain installed.

Slide the collector box off of the fuel hanger. Remove the 3 internal pump hanger bracket bolts using a 4mm Allen wrench. Set the bracket aside as shown.

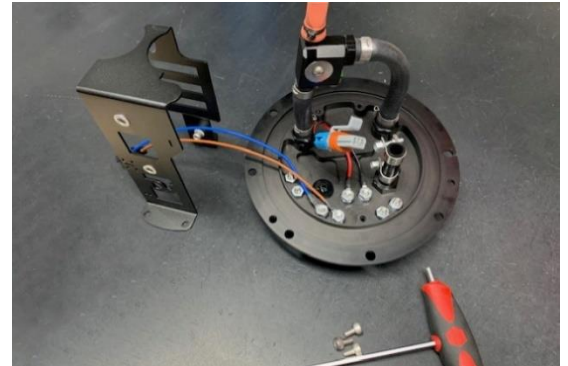

7. All units come ready for single pump installation. For dual pump applications, remove the port plug for the second pump using a 1/4" Allen wrench and install the included hose barb adapter fitting in the second port. Lubricate the O-ring with oil and tighten with a 3/8" socket.

Install the provided second pump wire harness to the terminals on the underside of the fuel hat. Secure the included jam nuts using a 3/8" wrench. IMPORTANT: Hold the power studs with a 3/8" socket on the opposite side to prevent the studs from turning when tightening the jam nut. Make sure that the red wire connects to the positive stud and the black wire connects to the negative. NOTE: For Bosch BR540 and Deatschwerks DW400 pumps, crimp the included ring terminals to the flying lead wire harness included with the pump.

If installing Bosch BR540/DW400 pumps, skip ahead to step 10a.



8. The submersible fuel tubing will need to be installed between the pump and fitting under the fuel hat. First, apply oil lubrication to all associated barbs and to both inner ends of the tubing. Gently apply force to push it onto the fuel pump outlet barb.

NOTES:

1. Fuel pump hose barbs can fracture if not treated with extra care.
2. Extra tubing is provided in case of damage during assembly.

For many 300/320/340LPH pumps, low heat is required to temporarily soften the tubing. If this is the case, be careful not to over-heat and melt the tubing. If the tubing becomes too soft and deformed, replace it with a new piece.



9. The submersible fuel tubing is pre-cut to an exact length to match the specific pump noted in the kit. For proper fitment, the tube must be pushed as far down the pump outlet as possible. Care must be taken not to kink the tubing. If too much force is applied, replace the tube.

As shown, secure using one of the EFI hose clamps and a 9/32" nut driver.

If applicable, repeat this process for the second pump.



10. Slide a second hose clamp onto the tubing attached to the fuel pump. Use lubrication as previously mentioned and push the tube over the barb until it is fully seated. NOTE: Do NOT apply heat on this side of the tubing connection. It is NOT required.

Do not tighten this hose clamp yet. The fuel pump will first need to be rotated into the proper position.

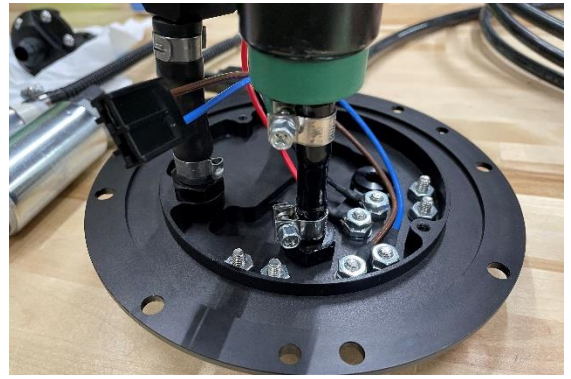

10a. Follow this step for Bosch BR540 and Deatschwerks DW400 fuel pumps ONLY

Taller pumps do not use the plastic tubing shown in other steps of this document. Instead, the included fuel pump outlet adapters (20-0599) are included in the fuel pump hanger kit 20-0781-00. Before proceeding, inspect the pump outlet hose barb. If the hose barb is deformed, modified or damaged, the Radium Engineering fuel pump outlet adapter will not install or seal correctly and the pump cannot be used.

Slide the black machined aluminum collar over the pump outlet with the flat surface upward as shown.



10b. Follow this step for Bosch BR540 and Deatschwerks DW400 fuel pumps ONLY

Slip the 2 stainless-steel retainers between the 2 large hose bars. When assembled, the retainers will lodge under the barb ridge closest to the end of the pump outlet.



10c. Follow this step for Bosch BR540 and Deatschwerks DW400 fuel pumps ONLY

Place the included O-ring on the fuel pump outlet, as shown. Apply a light coat of lubrication to the O-ring.



10d. Follow this step for Bosch BR540 and Deatschwerks DW400 fuel pumps ONLY

As shown, slide the black collar upward until it is resting against the retainer clips.



10e. Follow this step for Bosch BR540 and Deatschwerks DW400 fuel pumps ONLY

Line up the upper 6AN fitting holes to the lower fitting threads. This fitting should also be black (not green).

Apply a medium strength thread locking compound to the threads of the 3 included small screws. Secure and tighten all bolts evenly using a 2.5mm Allen wrench.

Lubricate the O-ring on the black male 6AN fitting and install the fuel pump into one of the ports on the underside of the top plate using a 15mm wrench. NOTE: Either of the 2 ports can be used as they share the same external outlet. If a single pump is being used, make sure the other port is plugged.



11. Install the fuel pump support bracket that was removed in step 6.

Secure the fuel pump(s) to the bracket using the large hose clamps.

Rotate the pumps for best alignment with the bracket. Tighten the hose clamps with a flat head screwdriver.

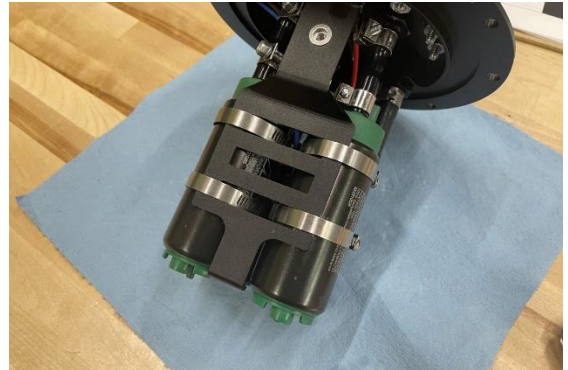

12. With the pumps aligned in the bracket, proceed to tighten the EFI-style hose clamps from step 10 using a 9/32" nut driver.



13. NOTE: The Radium fuel pump hanger was designed for a specific type of fuel pump sock filter. Large filter socks, which have a rigid internal "skeleton" insert are not recommended because they cannot fit inside the collector box. See below for filter socks that are recommended:

- RADIUM Engineering, P/N: 14-0143 Filter Sock (shown)
- AEM, P/N: 50-1200 (the filter sock provided in the AEM packaging)



14. Next, press the filter sock(s) onto each pump inlet and secure with the star washer included with the sock filter.



15. To install the fuel temperature sensor (if equipped), the collector box must first be removed from the assembly.

Cut the 2 black wires at the white OEM connector allowing as much slack as possible. Strip the wires and crimp the 2 included ring terminals using a standard crimp tool. Secure the ring terminals to the studs underneath the top hanger plate using a 3/8" nut driver. Note: the fuel temperature sensor does not have polarity so wires can be crossed and the readings are unaffected.

Wrap 2 cable zip ties through the bracket and secure the OEM fuel temperature sensor to the inner side of the bracket, as shown.

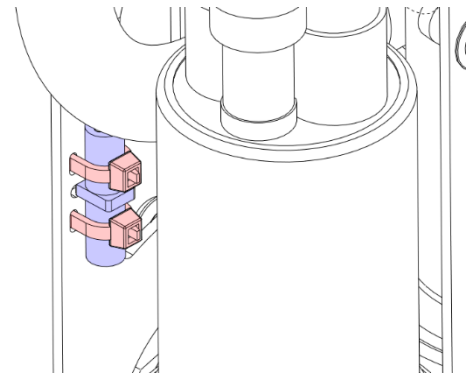

16. To connect the fuel level sensor, cut the 2 wires at the OEM white internal connector allowing as much slack as possible. Strip the wires and crimp the 2 included blade terminals using a tool such as Molex 63811-1000. Assemble the included mating connector as shown. Note: the sensor does not have polarity so wires can be crossed and readings are unaffected.

Install the assembly back into the collector box so the blue brown wire fuel level sender connector is outside the box. Route the 2 wires through the opening in the upper side of the collector box. Just install the single bolt on the one side of the collector box.

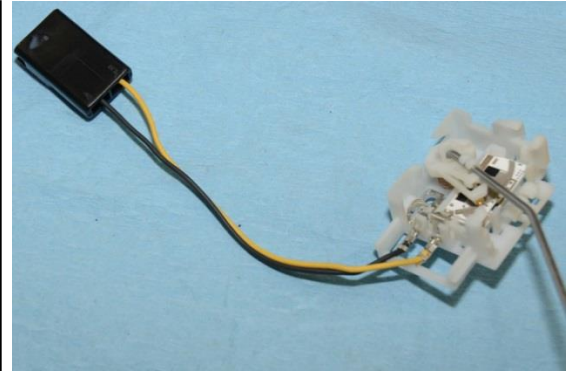

17. Make sure the 2 bolts holes (shown) on the collector box are removed.



18a. **20-0850 FUEL LEVEL SENDER ADAPTER, FA20**

The 20-0850 kit is for Subaru FA20 vehicles ONLY and is sold separately.

Install the provided block-off plate using the 2 collector box screws, as shown. On the opposing side of the collector box, remove the two lower button head bolts using a 3mm Allen hex wrench. These 2 bolts will NOT be reused.



18b. **20-0850 FUEL LEVEL SENDER ADAPTER, FA20**

The 20-0850 kit is for Subaru FA20 vehicles ONLY and is sold separately.

Line up the 2 upper holes of the included adapter to the rivet nuts. Install the new socket head bolts and tighten with a 4mm Allen hex wrench. Slide the OEM fuel level sensor downwards onto the adapter until the tab locks into place.

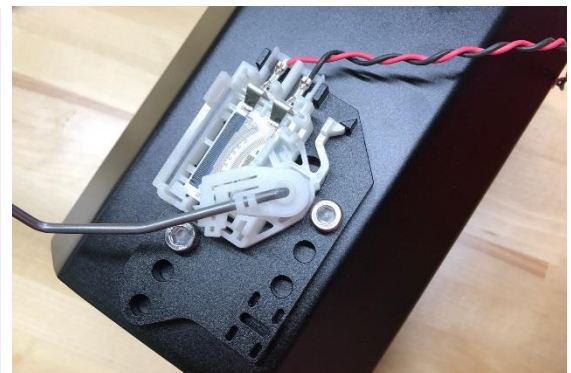

19. Excluding Subaru FA20F vehicle applications, slide the OEM fuel level sensor downwards onto the front of the collector box. Use the included bolt to secure the sender in place, as shown.

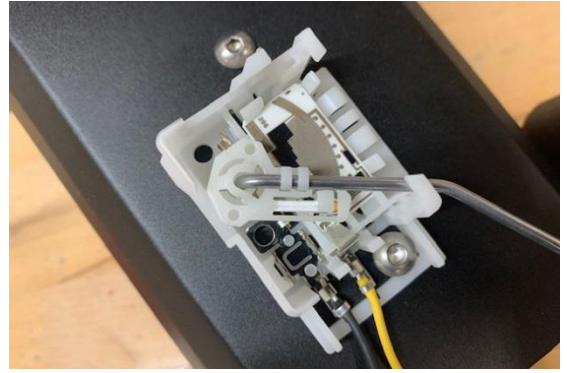

20. Twisting the internal fuel level wires together is recommended.

Plug in the fuel level sensor connector. Push the blue and brown wires into the collector box.

Install the OEM rubber gasket to the underside of the fuel hat. Make sure the rubber indicators are pointing upwards. NOTE: There is only one way this gasket will go on, so pay close attention and make sure it is oriented correctly.



21. Prepare to insert the fuel pump hanger assembly into the fuel tank.

Rotate and insert the float into the tank first. Next, drop the other side in bringing the assembly vertical. Moving the electrical connector around may be necessary for proper clearance.

Make note of the orientation graphic on the fuel hat is aligned correctly with the vehicle. Tighten all nuts to factory spec in an alternating cross-pattern.

Push the 3 SAE quick connectors on until a "click" is felt. Lubrication is recommended.



22. Cut off the OEM external 6-position fuel pump connector leaving as much slack as possible. Subaru models that do not have a fuel temperature sensor will only have 4 wires. Strip the ends of the wires, as shown.

NOTES:

1. Insert a small piece of shrink tube onto each wire, then crimp on the ring terminals included in the kit. Use the 4 smaller ring terminals on the fuel level (and fuel temperature sensor wires if equipped). If powering a single pump using the OEM wiring (check power requirements), crimp the two larger terminals on the pump power and ground wires.
2. If NOT directly powering a pump with the OEM fuel pump controller, solder wires to the pump power wire (Green/Yellow) and route this to a relay. Green/Red wire will not be used.

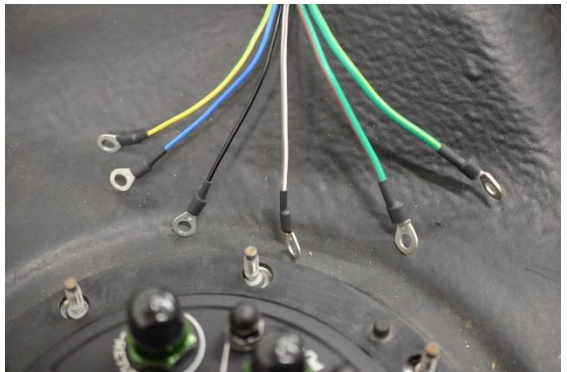

23. Slide the shrink tube in place then apply heat. Extra parts are provided in the kit as spares.

Connect the fuel temperature and fuel level wires to the corresponding terminals on the pump hanger. The sensor wires do not have polarity, so they can be connected to either terminal.

OEM Fuel Level Sender (Blue Wire)

OEM Fuel Level Sender (Black or Black/Yellow or Black/Red or Brown)

OEM Fuel Temp Sensor (White/Black Wire)

OEM Fuel Temp Sensor (Yellow/Green Wire)

Secure the ring terminals to the studs with the included acorn nuts. **DO NOT OVERTIGHTEN! If the stud rotates, it could cause a short on the underside of the hanger top plate.**



24. Dual Fuel Pump Applications ONLY:

Each fuel pump must use an independent fuse and relay to handle the extra current draw. Consider purchasing Radium 17-0031 (shown) for each pump. "Pump 2" in the hanger is powered through the studs labeled "Pump 2 +/-". Refer to the installation instructions for 17-0031 for additional details on wiring.

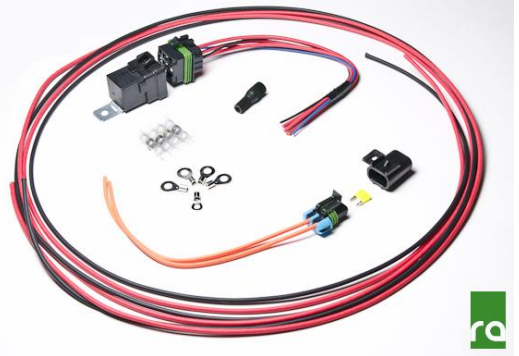

25. Single Fuel Pump Applications ONLY

In some cases, the OEM Subaru fuel pump controller and OEM wiring (designed for <15A) will be sufficient. To keep the fuel pump duty-cycled, connect "Pump 1" as follows:

OEM Fuel Pump + (Green/Yellow Wire) ----> Pump1 + terminal

OEM Fuel Pump - (Green/Red Wire) -----> Pump1 - terminal

Use the included ring terminals and heat shrink to connect the terminated wires to the fuel hat studs. Alternatively, the OEM fuel pump controller can be bypassed using Radium 17-0031 Wiring Kit, as shown. This schematic will run the pump at 100% duty cycle using power directly from the battery via the relay.

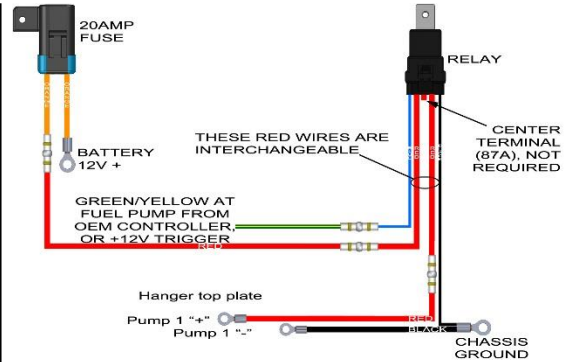

26. INSTALLATION: 20-0629-0X FUEL HANGER PLUMBING KIT, 08-21 SUBARU

Remove both the active side and passive side fuel tank access covers under the rear seat.

Remove the "fuel pump out" and the "FPR return" port fittings from the fuel hat.

Install the provided 8AN and 6AN fittings respectively.



27. INSTALLATION: 20-0629-0X FUEL HANGER PLUMBING KIT, 08-21 SUBARU

Under the rear seat sheet metal, 3 plastic fuel lines run between the active side and passive side of the fuel tank, as shown. Because this plumbing kit replaces the OEM feed and return lines, these two lines can be removed from the vehicle if necessary.

To remove, disconnect each end and unclip it from the bracket hidden in the cavity under the rear seat sheet metal (shown). For the lines that will remain in the vehicle, use high pressure air to empty each line and cap each end.

NOTE: The crossover fuel line that goes from the passive side to the active side of the fuel tank is still used and should be left intact.



28. INSTALLATION: 20-0629-0X FUEL HANGER PLUMBING KIT, 08-21 SUBARU

Find the fuel filter and adapter fittings provided in the kit.

Using light oil, lubricate the O-rings on the two 10AN ORB to 8AN male adapter fittings. Secure the fittings to the fuel filter ports using a non-marring 1" wrench.



29. INSTALLATION: 20-0629-0X FUEL HANGER PLUMBING KIT, 08-21 SUBARU

Find the 2-piece fuel filter mount and sheet metal bracket in the kit.

Secure the lower filter mount to the bracket as shown using a 4mm Allen wrench and 8mm wrench.



30. INSTALLATION: 20-0629-0X FUEL HANGER PLUMBING KIT, 08-21 SUBARU

Center the fuel filter in the lower mount. Make sure the green fuel filter outlet cap is pointing towards the small mounting hole on the bracket (or towards the engine when installed).

Using a 4mm Allen wrench, clamp the fuel filter using the upper mount and provided hardware.



31. INSTALLATION: 20-0629-0X FUEL HANGER PLUMBING KIT, 08-21 SUBARU

Safely lift the vehicle.

Find the area pictured located just inside of the front left wheel.

The fuel filter bracket will be mounted to the OEM holes shown.



32. INSTALLATION: 20-0629-0X FUEL HANGER PLUMBING KIT, 08-21 SUBARU

Peel the protective covering off both spots.



33. INSTALLATION: 20-0629-0X FUEL HANGER PLUMBING KIT, 08-21 SUBARU

Using 14mm and 10mm wrenches, secure the fuel filter bracket to the chassis, as shown.



34. INSTALLATION: 20-0629-0X FUEL HANGER PLUMBING KIT, 08-21 SUBARU

Just inside the LH rear tire and forward will be 2 protective shields underneath the vehicle.

Unscrew all protective shield bolts/nuts.



35. INSTALLATION: 20-0629-0X FUEL HANGER PLUMBING KIT, 08-21 SUBARU

Temporarily remove the protective shields from the vehicle. The rear shield from a 2008-2014 Impreza WRX is depicted.



36. INSTALLATION: 20-0629-0X FUEL HANGER PLUMBING KIT, 08-21 SUBARU

The next step is to secure the 3 provided hose retainers underneath the vehicle, as shown.

NOTES:

1. The front hose separator will be temporarily secured with the 14mm hex head sheet metal screw. In some unibodies, the hole is 8mm. Drill the hole but do not exceed 8.5mm (.335").
2. The middle hose separator will use the provided socket head M6x1mm bolt. Temporarily secure with a 5mm Allen wrench with no washer installed.
3. Depending on the model year, the rear hose separator will be secured with either the 10mm hex head M6x1mm bolt or 12mm hex head M8x1.25mm bolt into the rear most threaded boss.



37. INSTALLATION: 20-0629-0X FUEL HANGER PLUMBING KIT, 08-21 SUBARU

The next steps will be securing the 2 fuel hoses one by one starting from the fuel filter and working back towards the rear of the vehicle.

Push the -6AN (3/8") fuel hose into the engine bay. Position the end of the hose where the FPR return port is located. NOTE: This hose will be cut to length and terminated in later steps. Screw the -8AN 45 degree hose end to the fuel filter inlet fitting.

NOTE: Always position hoses away from hot and/or tight areas that could chafe the hose.



38. INSTALLATION: 20-0629-0X FUEL HANGER PLUMBING KIT, 08-21 SUBARU

The -8AN PTFE fuel feed hose will be routed on the inner side and the -6AN (3/8") return hose on the outer side.

Place the fuel feed and return lines into their respective hose retainer slots, as shown.



39. INSTALLATION: 20-0629-0X FUEL HANGER PLUMBING KIT, 08-21 SUBARU

Fasten the hoses under the car near the transmission using the provided clamp and a 15mm socket, as shown.

At the rear, send the hoses up just in front of the fuel tank. For clearance, the hoses will need to be routed towards the outer front portion of the fuel tank.

From the interior, pull the hoses up and out of the LH fuel tank access hole. Next, send each hose underneath the sheet metal and out of the RH fuel tank access hole.



40. INSTALLATION: 20-0629-0X FUEL HANGER PLUMBING KIT, 08-21 SUBARU

Mock up the front protective shield (2015-2021 shown). Cut in the areas that interfere with the hose/retainers. Depending on the chassis, these cuts will vary slightly.

NOTE: the front fuel line retainer will need to be removed and installed on top of the protective shield.

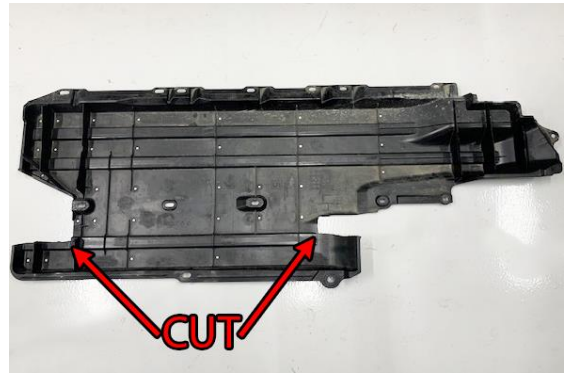

41. INSTALLATION: 20-0629-0X FUEL HANGER PLUMBING KIT, 08-21 SUBARU

To prevent chaffing, the rearmost protective shield (2008-2014 shown) will need to be slightly modified.

Reinstall the rearmost protective shield and make any necessary corrections.



42. INSTALLATION: 20-0629-0X FUEL HANGER PLUMBING KIT, 08-21 SUBARU

Note the cut protective shield pictured.

Next, fasten the 2 fuel lines to the rear 2 hose retainers using the provided cable zip ties. Once tight, cut off the cable zip tie tails using diagonal cutters.



43. INSTALLATION: 20-0629-0X FUEL HANGER PLUMBING KIT, 08-21 SUBARU

Near the fuel filter, secure the fuel lines using the provided cable zip ties. For LHD vehicles, pay close attention to the steering arm.



44. INSTALLATION: 20-0629-0X FUEL HANGER PLUMBING KIT, 08-21 SUBARU

Remove the front hose separator. Install the front protective shield. Reinsert the fuel hoses into the front retainer and secure over the front protective shield, as shown.

Fasten the 2 fuel lines to the front hose retainer using the provided cable zip ties. Once tight, cut off the cable zip tie tails using diagonal cutters.



45. INSTALLATION: 20-0629-0X FUEL HANGER PLUMBING KIT, 08-21 SUBARU

Reinstall the front protective shield using all OEM fasteners. Two will be left unused.

The rear most hose retainer is shown.

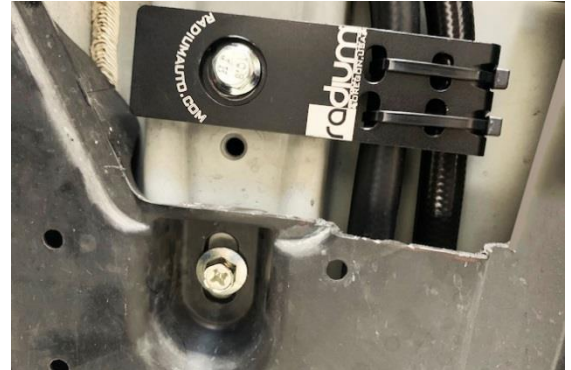

46. INSTALLATION: 20-0629-0X FUEL HANGER PLUMBING KIT, 08-21 SUBARU

Reinstall the front protective shield using all of the OEM fasteners excluding two.

The socket head bolt in the middle hose retainer will be on the opposite side as depicted.



47. INSTALLATION: 20-0629-0X FUEL HANGER PLUMBING KIT, 08-21 SUBARU

Using a 5mm Allen wrench, loosen the socket head bolt.

As shown, remove the socket head bolt through the slot.



48. INSTALLATION: 20-0629-0X FUEL HANGER PLUMBING KIT, 08-21 SUBARU

Slide the provided fender washer onto the socket head bolt and reinstall as shown. Secure using a 5mm Allen wrench.



49. INSTALLATION: 20-0629-0X FUEL HANGER PLUMBING KIT, 08-21 SUBARU

In the RH fuel tank access hole, install the 8AN feed hose to the fuel pump out fitting.



50. INSTALLATION: 20-0629-0X FUEL HANGER PLUMBING KIT, 08-21 SUBARU

Temporarily install the provided 45 degree -6AN PushLok hose end to the FPR return port fitting. Line up the return hose to the hose end and cut to length.

To install the hose end, first lubricate the PushLok hose end barbs with oil. Push the return hose over the barbs until fully seated. NOTE: hose clamps are NOT necessary for PushLok connections. Secure the return hose to the FPR return port fitting using an 11/16" non-marring wrench.



51. INSTALLATION: 20-0629-0X FUEL HANGER PLUMBING KIT, 08-21 SUBARU

If there is not an -8AN male fitting on the fuel rail, apply oil and install the provided -8AN fitting.

Next, install the included -8AN 45deg hose end to the provided -8AN (1/2") hose. First, lubricate the PushLok barbs with oil, then push the hose on until fully seated. Install the hose end to the fuel filter outlet. Carefully route the feed hose towards the fuel rail and cut to length.

Finally, install the included -8AN and -6AN 90deg hose ends in the same manner to finalize the feed and return hoses. As shown, a vice can be helpful. NOTE: hose clamps are NOT necessary for PushLok connections. Secure the hose ends using 7/8" and 11/16" non-marring wrenches.



52. INSTALLATION: 20-0629-0X FUEL HANGER PLUMBING KIT, 08-21 SUBARU

Reinstall the OEM metal cover plates. Reconnect the battery and turn the key to the ON position.

NOTE: There will be leftover parts from the kit that will not be used in every situation.

Confirm the new fuel pumps prime for a few seconds and check for leaks. If no leaks are found, start the vehicle. The engine may run rough for a few seconds until all the air is bled from the fuel system. Recheck for leaks.

INSTALLATION COMPLETE

