



Installation Instructions for 30-4110NS “No Sensor” Gauge-Type UEGO Controller

WARNING:



This installation is not for the electrically or mechanically challenged! Use this sensor with **EXTREME** caution! If you are uncomfortable with anything about this, please refer the installation to an AEM trained tuning shop or call 800-423-0046 for technical assistance. You should also visit the AEM Performance Electronics Forum at <http://www.aempower.com>

NOTE: AEM holds no responsibility for any engine damage that results from the misuse of this product!

This product is legal in California for racing vehicles only and should never be used on public highways.

ADVANCED ENGINE MANAGEMENT INC.
2205 126th Street Unit A, Hawthorne, CA. 90250
Phone: (310) 484-2322 Fax: (310) 484-0152
<http://www.aemelectronics.com>
Instruction Part Number: 10-4110NS Rev 151130
© 2015 Advanced Engine Management, Inc.

AEM Gauge-Type UEGO Controller Parts

- 1 x UEGO Gauge Assembly
- 1 x O2 Sensor Bung
- 4 x Butt Connectors
- 1 x Installation Instruction
- 1 x 4 Lead Harness
- 1 x UEGO Sensor Harness
- 1 x Silver Bezel
- 1 x Black Lambda Faceplate
- 1 x White AFR Faceplate

Replacement Wideband Controller Components

- 30-2004 Replacement Bosch LSU49 Sensor
- 35-3441 96" Wideband LSU49 UEGO Sensor Replacement Cable
- 35-3401 36" Wideband UEGO Power Replacement Cable
- 35-4005 Mild Steel Oxygen Sensor Bung (welding required)
- 35-4001 Mild Steel Sensor Bung Plug
- 30-4008 Stainless Steel Tall Finned Oxygen Sensor Bung (welding required)

IMPORTANT NOTE:

The 30-4110NS kit is NOT supplied with a wideband sensor. The following sensors are approved for use with this, and only this, product:

Manufacturer	Part Number	Description
AEM	30-2004	Bosch LSU4.9 (950mm)
Bosch	17025	Bosch LSU4.9 (950mm)
Walker	250-25036	Bosch LSU4.9 (950mm)
Walker	250-25075	Bosch LSU4.9 (325mm)

Congratulations! The 52mm (2-1/16") AEM Universal Exhaust Gas Oxygen (UEGO) Gauge features a digital readout and sweeping 24 color-coded light emitting diode (LED) display, providing immediate reference to the engine air fuel ratio (or lambda) in real-time. The AEM gauge is ideal for all vehicles including carbureted applications and engine dynamometers. A user-selectable 0-5V analog output is included and can be used with data loggers as well as most Electronic Fuel Injection (EFI) systems including the AEM Engine Management System (EMS). A serial data stream is also integrated for air fuel (or lambda) ratio output to a RS-232 com port.

Because the AEM gauge utilizes the internal AEM UEGO controller and Bosch UEGO Sensor, it is accurate and repeatable to 0.1 of an air/fuel ratio point! With this, there is no abrupt oscillation as found in many competitor gauges, which utilize a narrow band oxygen sensor detecting only stoichiometry.

Typical production vehicle oxygen sensors rely on “Nernst Cell” technology, commonly called “Narrow Band” and sometimes erroneously described as “Wide Band”. This is a very cost effective method that outputs a voltage based on the oxygen content of the gas being sampled. It is accurate in the region surrounding stoichiometric operation and leaner. Unfortunately, in the rich region where high performance engines usually operate, their accuracy and repeatability is virtually non-existent. (Figure 1)

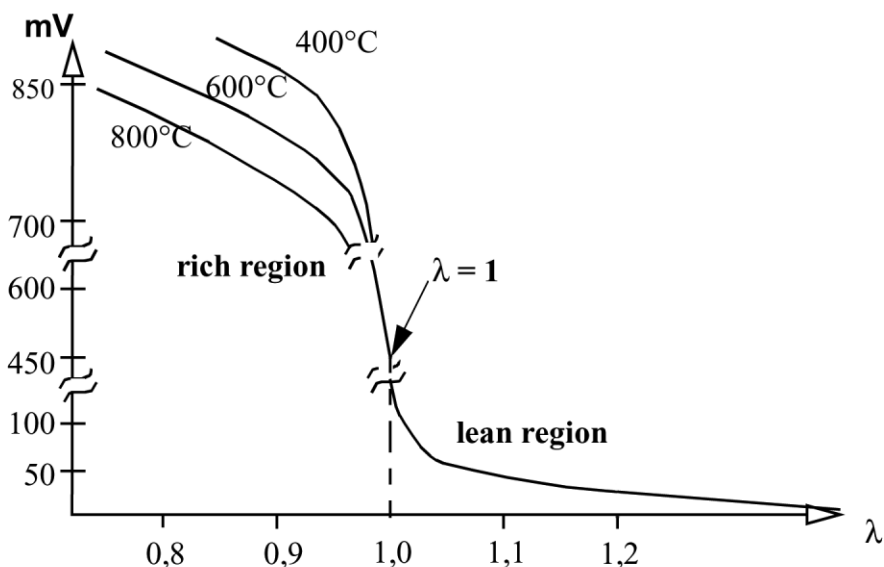

Figure 1. Characteristic curve of a Nernst Cell O₂ Sensor

The rich region output of narrow band O₂ sensors is temperature dependent, which renders it useless if an accuracy better than 1.5:1 AFR is desired. This is immediately obvious given the fact that a single output voltage actually represents wildly different air fuel ratios depending on the unregulated and unmeasured sensor temperature. These sensors were designed for operating closed loop around stoichiometry (14.64:1 for gasoline), and for performance tuning they are useless.

The heart of the AEM gauge is the Bosch LSU4.9 Universal Exhaust Gas Oxygen (UEGO) sensor. This type of sensor is commonly referred to as “laboratory grade” and works on a different principle than the narrow band oxygen sensor found in most vehicles. Its unique design makes precision AFR measurements possible over the entire operating range.

UEGO sensors use a “current pump” to determine the actual oxygen concentration within the sensing element. The output is in the form of a very small current, which varies depending on the air-fuel ratio. This is completely different from a narrow band oxygen sensor, which directly outputs a voltage. The UEGO sensor design allows measurement of the exact air fuel ratio over the entire operating range.

Each AEM UEGO sensor is individually calibrated and a resistor integral at the connector body is laser trimmed with this value. This process replaces the “free air” calibration procedure required by some manufacturers when changing sensors and implements a sensor specific calibration for unparalleled accuracy. (Figure 2)



Figure 2. The connector module contains a laser trimmed calibration resistor, which defines the characteristic of the sensor.

INSTALLATION

Disconnect the negative (-) battery cable. There are two harnesses that connect to the back of the AEM UEGO gauge. The longer harness connects to the UEGO sensor. The shorter harness contains four leads. The red and black leads must be connected in order for the gauge to function. Connection of the white and blue wires is optional. Connect the wires as shown below. (Figure 3) The harness ends with the four and six pin connectors connect to the back of the gauge. When looking at the back of the gauge as shown below, the six-pin connector connects on the left side and the four pin on the right side. The locating tabs on the four and six pin connectors should be facing up. (Figure 4)

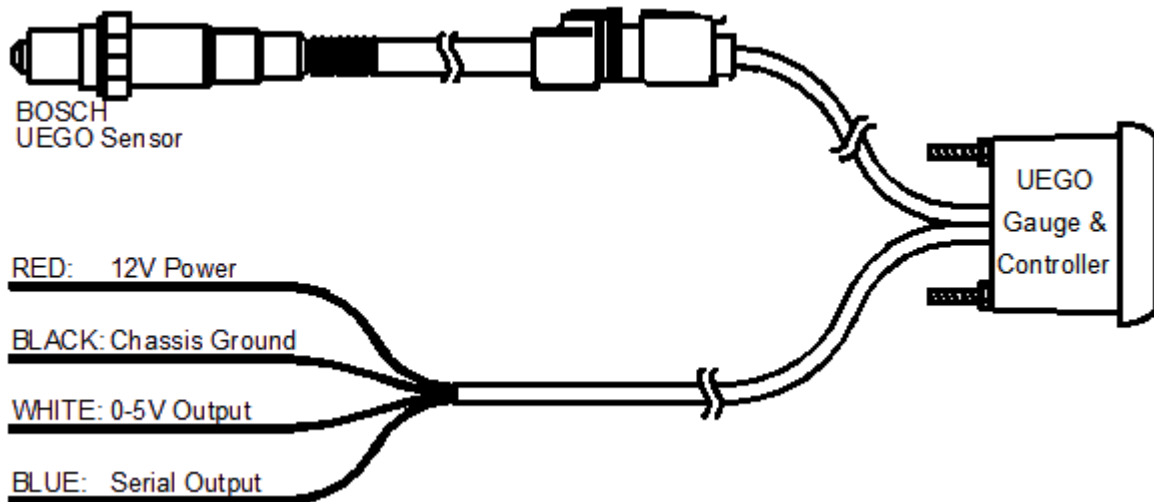

Figure 3. Gauge Installation Connections



Figure 4. Gauge Side Harness Connections

RED <Power>

Connect to a switched 10-18 volt power source utilizing a 10A fuse.

BLACK <Ground>

Connect to a clean power ground.

*WHITE <Analog Output>

Connects to any auxiliary unit that accepts a 0-5 volt input.

*BLUE <Serial Output>

Connects to a RS-232 com port for hyper-terminal data logging.

*optional

Analog Output

(Skip this section if you are not connecting the product to an AEM EMS.)

If the AEM UEGO gauge is to be connected to an AEM EMS, the UEGO gauge's WHITE Analog Output wire shall be connected to an EMS Lambda input. Locating a suitable Lambda input channel can be done using the Application Notes provided with the EMS. If the Application Notes are not readily accessible, a current list of AEM Engine Management Systems is illustrated below. (Table 1)

AEM Series 2 EMS P/N	Lambda #1 Pin	Lambda #2 Pin	Sensor GND Pin
30-6100/30-6101	B47	B48	B65
30-6010/6012/6050/6052	C16	A23	C18
30-6000/6001/6002/6040/6042	D14	D16	D21
30-6060	D7	D14	D12
30-6310/30-6311/30-6313	76	75	92
30-6320	71	73	34
AEM EMS-4	Lambda #1 Pin		Sensor GND Pin
30-6905	20		35
AEM Series 1 EMS P/N	Lambda #1 Pin	Lambda #2 Pin	Sensor GND Pin
30-1000/1001/1002/1040/1042	D14	D16	D21
30-1010/1012/1050/1052	C16	A23	C18
30-1020/1060	D7	D14	D12
30-1030/1031/1070	C13	C14	A16
30-1080	C16	C8	C14
30-1081	C16	B11	C14
30-1100/1101	B47	B48	B65
30-1110	1C	9C	13C
30-1120/1121/1130	B6	B14	B9
30-1220	30	31	60
30-1300	4	66	17
30-1310/1311/1312/1313	76	75	92
30-1320	71	73	34
30-1400	29	43	46
30-1401	44	43	46
30-1510	C2-31	C2-33	C2-32
30-1600/1601/1602/1603	19	NA	21
30-1610/1611/1612	46	52	50
30-1620/1621/1622/1623	29	55	30
30-1710	2N	4J	2C
30-1720	C3	D3	O3
30-1800	C3	A2	D4
30-1810	D19	B17	B19
30-1820/1821	A26	D25	C35

Table 1. Lambda input channel locations for AEM EMS

Below (Table 2) is a list of AFR values that should be entered into the O2 Sensor #1(#2) Cal Table if inputting the analog signal to an AEM EMS. These calibration table(s) are found in the AEMPro software: Setup | Sensors | Oxygen Sensor | Oxygen Sensor #1(#2)

O2 Volts	Lambda	Gasoline AFR	Methanol AFR	Propane AFR	Ethanol AFR	CNG AFR
0.00	0.683	10.00	4.42	10.72	6.15	9.90
0.16	0.705	10.32	4.56	11.07	6.34	10.22
0.31	0.725	10.62	4.69	11.39	6.53	10.52
0.47	0.747	10.94	4.83	11.73	6.73	10.84
0.62	0.768	11.24	4.97	12.05	6.91	11.13
0.78	0.790	11.56	5.11	12.40	7.11	11.45
0.94	0.811	11.88	5.25	12.74	7.30	11.77
1.09	0.832	12.18	5.38	13.06	7.49	12.06
1.25	0.854	12.50	5.52	13.41	7.68	12.38
1.40	0.874	12.80	5.66	13.73	7.87	12.68
1.56	0.896	13.12	5.80	14.07	8.07	12.99
1.72	0.918	13.44	5.94	14.41	8.26	13.31
1.87	0.939	13.74	6.07	14.73	8.45	13.61
2.03	0.960	14.06	6.21	15.08	8.64	13.93
2.18	0.981	14.36	6.35	15.40	8.83	14.22
2.34	1.003	14.68	6.49	15.74	9.02	14.54
2.50	1.025	15.00	6.63	16.09	9.22	14.86
2.65	1.045	15.30	6.76	16.41	9.41	15.15
2.81	1.067	15.62	6.90	16.75	9.60	15.47
2.96	1.087	15.92	7.04	17.07	9.79	15.77
3.12	1.109	16.24	7.18	17.42	9.98	16.08
3.28	1.130	16.54	7.31	17.74	10.17	16.38
3.43	1.152	16.86	7.45	18.08	10.36	16.70
3.59	1.173	17.18	7.59	18.42	10.56	17.02
3.74	1.194	17.48	7.73	18.75	10.75	17.31
3.90	1.216	17.80	7.87	19.09	10.94	17.63
4.06	1.236	18.10	8.00	19.41	11.13	17.93
4.21	1.258	18.42	8.14	19.75	11.32	18.24
4.37	1.280	18.74	8.28	20.10	11.52	18.56
4.52	1.301	19.04	8.41	20.42	11.70	18.86
4.68	1.322	19.36	8.56	20.76	11.90	19.17
4.84	1.343	19.66	8.69	21.08	12.09	19.47
4.99	1.365	19.98	8.83	21.43	12.28	19.79

Table 2. EMS Calibration Tables, P0 mode

When connecting to AEM's Series1 EMS, make sure to verify that the O2 #1 Gain option is set so the voltage from the O2 #1 Volts parameter matches the voltage input at the EMS from the O2 sensor. An easy way to do this is to disconnect the UEGO sensor from the UEGO gauge. When in this state, the UEGO gauge will output 2.35 volts. You can then adjust the O2 #1 Gain until the O2 #1 Volts display in AEMPro reads 2.35 volts.

When connecting to AEM's Series2 EMS,

1. Unplug the O2 Sensor from the 30-4110 Gauge.
2. Open up the O2 Calibration Setup Wizard by navigating to Wizards -> Setup Wizard -> Sensor: O2 #1 (AFR)
3. Double click the AEM Digital Gauge (PN 30-4100) it will highlight and display matched.
4. Click Apply and close screen.
5. Note: The 'O2 Gain' options have been removed from Series2 EMS firmware.
6. Next navigate to the O2 Sensor #1 Cal Table. This can be done by clicking on the Sensors Tab at the top of the screen or using the Display Explorer.
 - a. Display Explorer navigation – Display -> Display Explorer -> Setup -> Sensors -> Oxygen Sensor(s) -> O2 Sensor #1 Cal
 - b. Double click to open the following tables. Channels – O2 Sensors & O2 Sensor #1 Cal
7. Channels – O2 Sensor Table
 - a. With the Gauge-Type UEGO Sensor unplugged the O2 #1 Volts parameter should read 2.32V (+/- .02 Volts)
 - b. With the Gauge-Type UEGO Sensor unplugged the O2 #1 should match the gauge display at 14.7AFR.
 - c. If the channel in AEMtuner is not displaying the correct 14.7 AFR value. Select the entire 'O2 Sensor #1 Cal' table and increase or decrease until the EMS matches the gauge display.

When connecting to a third party EFI system, the AEM UEGO gauge's WHITE Analog Output wire shall be connected to the analog O2 sensor input of that system. Consult the documentation provided with the system for detailed instructions.

Serial Output

The serial output can be used for data logging when an EFI system is not accessible. To run the data stream, a RS-232 (DB-9) Female Receptacle shall be purchased.

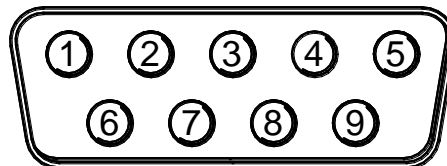

Figure 5. Wire View of RS-232 (DB-9) Male Plug

Two wires need to be connected to a RS-232 serial port. The BLUE wire from the AEM UEGO Gauge shall be connected to Pin #2 (RX) on the serial port for receiving data. Pin # 5 (GND) on the serial port shall be grounded. If a standard 9-pin serial cable is to be cut instead, the (RX) wire is typically RED and the (GND) wire is typically GREEN. However, this should be confirmed with a continuity tester before attempting. (Figure 5)

Use HyperTerminal for testing the data stream. This software is found on most PCs prior to Windows 7; other operating systems will require locating alternative terminal software such as TeraTerm or RealTerm. To find HyperTerminal go to: Start | All Programs | Accessories | Communications | HyperTerminal. Name the New Connection and click OK. Set the COM port to the one being used and click OK.

Bits per Second = 9600
 Data Bits = 8
 Parity = None
 Stop Bits = 1
 Flow Control = Hardware

IMPORTANT INSTALLATION NOTE - UEGO Sensor Mounting Orientation

A weld-in M18 X 1.5 boss is supplied for sensor installation. Mount the O2 sensor in the exhaust system at least 18 inches downstream from the exhaust port. If you anticipate high EGT's (over 800C), run a turbocharger, run at high RPM for extended periods of time or plan on running leaded race fuel then you must mount the sensor at least 36 inches or more downstream of the exhaust port as all of these can cause the sensor to overheat. **On turbocharged engines the UEGO sensor must be installed after the turbo charger, if not, the pressure differential will greatly affect the accuracy of the unit.** For accurate readings, the sensor must be mounted before catalytic converters and/or auxiliary air pumps. To prevent collection of liquids between the sensor housing and sensor element during the cold start phase, the installation angle should be inclined at least 10° from horizontal with the electrical connection upwards, see below. (Figure 8)

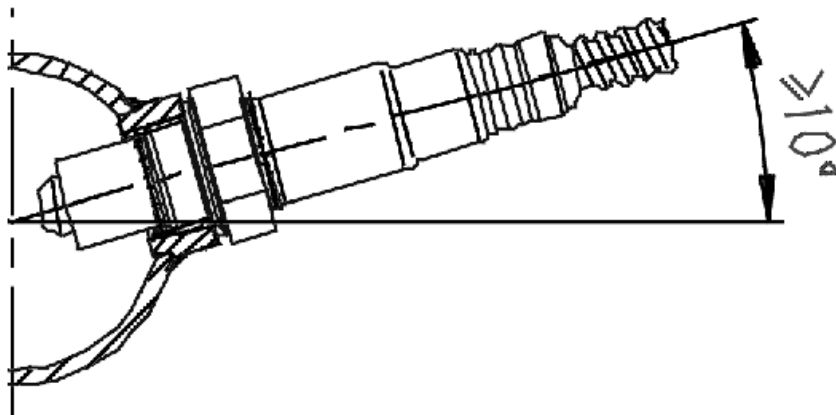

Figure 8. Minimum mounting angle for the UEGO Sensor

Configuring Calibration Outputs

The AEM default position is (P0). When set to (P0) (Figure 10A), the gauge displays AFR values. (P1) is the same as (P0), except the gauge displays lambda values. These settings (P1 and P0) implement a linear calibration with the most useful voltage range possible (0-5V). The AFR calibration (P2) is linear and similar to (P1) with a smaller voltage range (1-2V). The AFR calibration (P3) emulates the Autronic Wideband O2 Sensor calibration (0-1V). The AFR calibration (P4) emulates a non-linear Nernst Cell calibration (0-1V). Refer to the [Table 3](#) and [Figure 9](#) for specific calibration details.

LED Number	LED Color	Lambda (λ)	AFR (Gasoline)			Analog Output Voltage Modes				
			AFR	LED "ON" Range		P0	P1	P2	P3	P4
LED 1	Green	0.683	10	Rich	Rich	0.000	0.000	1.000	0.000	0.905
LED 1	Green	0.700	10.25	Rich	Rich	0.125	0.125	1.025	0.013	0.904
LED 1	Green	0.717	10.5	Rich	Rich	0.250	0.250	1.050	0.025	0.903
LED 1	Green	0.734	10.75	Rich	Rich	0.375	0.375	1.075	0.038	0.902
LED 1	Green	0.751	11.00	Rich	11.125	0.500	0.500	1.100	0.050	0.901
LED 2	Green	0.768	11.25	11.125	11.375	0.625	0.625	1.125	0.063	0.900
LED 3	Green	0.786	11.50	11.375	11.625	0.750	0.750	1.150	0.075	0.890
LED 4	Green	0.803	11.75	11.625	11.875	0.875	0.875	1.175	0.088	0.880
LED 5	Green	0.820	12.00	11.875	12.125	1.000	1.000	1.200	0.100	0.870
LED 6	Green	0.837	12.25	12.125	12.375	1.125	1.125	1.225	0.113	0.860
LED 7	Green	0.854	12.50	12.375	12.625	1.250	1.250	1.250	0.125	0.850
LED 8	Green	0.871	12.75	12.625	12.875	1.375	1.375	1.275	0.138	0.840
LED 9	Green	0.888	13.00	12.875	13.125	1.500	1.500	1.300	0.150	0.830
LED 10	Green	0.905	13.25	13.125	13.375	1.625	1.625	1.325	0.163	0.820
LED 11	Green	0.922	13.50	13.375	13.625	1.750	1.750	1.350	0.175	0.800
LED 12	Yellow	0.939	13.75	13.625	13.875	1.875	1.875	1.375	0.188	0.775
LED 13	Yellow	0.956	14.00	13.875	14.125	2.000	2.000	1.400	0.200	0.750
LED 14	Yellow	0.973	14.25	14.125	14.375	2.125	2.125	1.425	0.213	0.700
LED 15	Yellow	0.990	14.50	14.375	14.625	2.250	2.250	1.450	0.225	0.600
LED 16	Yellow	1.008	14.75	14.625	14.875	2.375	2.375	1.475	0.238	0.410
LED 17	Yellow	1.025	15.00	14.875	15.125	2.500	2.500	1.500	0.250	0.240
LED 18	Yellow	1.042	15.25	15.125	15.375	2.625	2.625	1.525	0.263	0.170
LED 19	Yellow	1.059	15.50	15.375	15.625	2.750	2.750	1.550	0.275	0.137
LED 20	Yellow	1.076	15.75	15.625	15.875	2.875	2.875	1.575	0.288	0.113
LED 21	Red	1.093	16.00	15.875	16.125	3.000	3.000	1.600	0.300	0.100
LED 22	Red	1.110	16.25	16.125	16.375	3.125	3.125	1.625	0.313	0.091
LED 23	Red	1.127	16.50	16.375	16.625	3.250	3.250	1.650	0.325	0.083
LED 24	Red	1.144	16.75	16.625	Lean	3.375	3.375	1.675	0.338	0.077
LED 24	Red	1.161	17.00	Lean	Lean	3.500	3.500	1.700	0.350	0.076
LED 24	Red	1.178	17.25	Lean	Lean	3.625	3.625	1.725	0.363	0.075
LED 24	Red	1.195	17.50	Lean	Lean	3.750	3.750	1.750	0.375	0.074
LED 24	Red	1.212	17.75	Lean	Lean	3.875	3.875	1.775	0.388	0.073
LED 24	Red	1.230	18.00	Lean	Lean	4.000	4.000	1.800	0.400	0.072
LED 24	Red	1.247	18.25	Lean	Lean	4.125	4.125	1.825	0.413	0.071
LED 24	Red	1.264	18.50	Lean	Lean	4.250	4.250	1.850	0.425	0.070

Table 3. Calibration table of available outputs

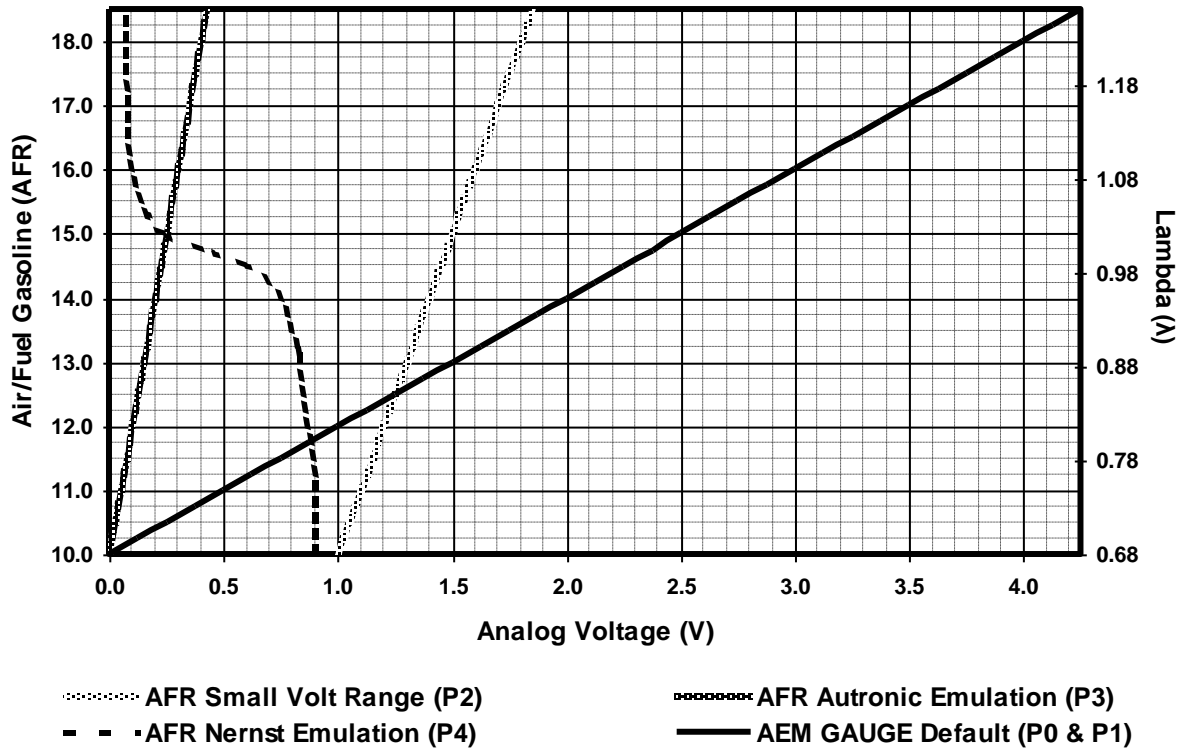

Figure 9. Calibration graph of available outputs

To change the calibrations, a precision flat head screwdriver is needed. Locate the small hole located on the back of the AEM gauge, as shown below. (Figure 10)

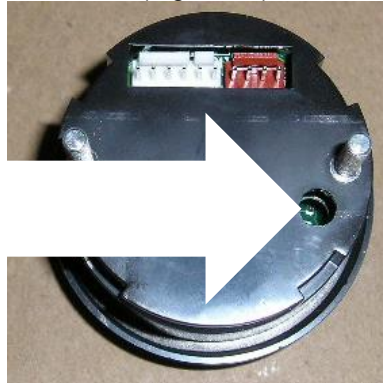

Figure 10. Calibration position screw location

With the screwdriver, clock the rotary switch into the desired calibration position, referring to the diagram below (Figure 10A), and watch the alphanumeric readout, which will display the new position when entered.

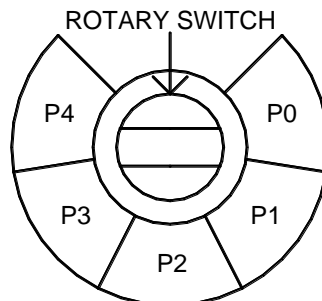

Figure 10A. Calibration screw position settings

The calibration will not be changed until the rotary switch reaches the middle of the new position.

Changing the gauge configuration

The AEM UEGO gauge comes configured with the black bezel and the black AFR faceplate. However, a silver bezel, a white AFR faceplate, and a black Lambda faceplate are also included in the gauge kit. To change the faceplate or bezel, orient the gauge so you are looking at the faceplate. Rotate the bezel counter-clockwise to unscrew it from the gauge cup. The bezel, glass lens, rubber spacer, faceplate, and anti-glare shield are all removable. Reassemble the gauge as shown in the photo below. Make sure the small light holes in the faceplate and anti-glare shield line up with the light sensor on the circuit board. Do not over tighten the bezel when reassembling the gauge. (Figure 11)



Figure 11. Gauge Assembly

For your reference, below is the multiplier for calculating the Air Fuel Ratio (AFR) of common fuels from the Lambda value.

Gasoline AFR	=	Lambda x 14.64
Methanol AFR	=	Lambda x 6.47
Propane AFR	=	Lambda x 15.7
Ethanol AFR	=	Lambda x 9.00
CNG AFR	=	Lambda x 14.5

Specifications:

Gauge

Supply Current (nominal):	1.3 amps
0-5V Analog Outputs:	1
Measuring Range: Sweeping LED	0.751 to 1.143 Lambda
Measuring Range: Numerical Display	10.0:1 to 18.5:1 AFR Gasoline
Harness & Connector Temp Limit:	105C

Sensor

Type:	Bosch UEGO LSU4.9
Accuracy:	+/- 0.7%
Exhaust Temp Limit:	1030C
Cable & Protector Sleeve Temp Limit:	250C
Connector Temp Limit:	120C
Initial Warm-up Time:	Less than 20 seconds
Weight:	80 grams
Heater Current:	1.2A at 12.0V (each sensor)
Mounting:	M18 X 1.5 thread, Torque to 30 ft-lbs
Nominal Service Life:	80,000 km for Unleaded Fuel
	50,000 km for Leaded Fuel 0.15g Pb/l
	20,000 km for Leaded Fuel 0.40g Pb/l
	10,000 km for Leaded Fuel 0.60g Pb/l

IMPORTANT Notes – PLEASE READ

The sensor contains a ceramic module and should not be subject to mechanical or thermal shock or it may be damaged. The sensor is not designed for operation on leaded fuels, doing so will dramatically shorten sensor life. Long term running in the rich region ($\text{Lambda} < 0.95$) will shorten sensor life. High exhaust temperatures (over 850C) will shorten sensor life. Engine oil consumption at a rate greater than 1 quart per 1,000 miles will shorten sensor life. With the UEGO Sensor installed, do not run the engine without power applied to the gauge.

12 MONTH LIMITED WARRANTY

Advanced Engine Management Inc. warrants to the consumer that all AEM High Performance products will be free from defects in material and workmanship for a period of twelve (12) months from date of the original purchase. Products that fail within this 12-month warranty period will be repaired or replaced at AEM's option, when determined by AEM that the product failed due to defects in material or workmanship. This warranty is limited to the repair or replacement of the AEM part. In no event shall this warranty exceed the original purchase price of the AEM part nor shall AEM be responsible for special, incidental or consequential damages or cost incurred due to the failure of this product. The Bosch LSU 4.9 UEGO sensor has a limited life and is not warranted. Warranty claims to AEM must be transportation prepaid and accompanied with dated proof of purchase. This warranty applies only to the original purchaser of product and is non-transferable. All implied warranties shall be limited in duration to the said 12 month warranty period. Improper use or installation, accident, abuse, unauthorized repairs or alterations voids this warranty. AEM disclaims any liability for consequential damages due to breach of any written or implied warranty on all products manufactured by AEM. Warranty returns will only be accepted by AEM when accompanied by a valid Return Goods Authorization (RGA) number. Product must be received by AEM within 30 days of the date the RGA is issued.

Please note that before AEM can issue an RGA for any product, it is first necessary for the installer or end user to contact the AEM Performance Electronics tech line at 1-800-423-0046 to discuss the problem. Most issues can be resolved over the phone. Under no circumstances should a system be returned or a RGA requested before the above process transpires.

Need additional help? Contact the AEM Performance Electronics tech department at 1-800-423-0046 or tech@aempower.com, or visit the AEM Performance Electronics forum at <http://forum.aempower.com/forum/>